



IP2320 • 2020-09-02

Ditec OLLY C



Ditec

Manuale di installazione e manutenzione per automazioni per porte scorrevoli interne.

Installation and maintenance manual for automations for internal sliding doors.

Manuel d'installation et d'entretien pour automation de portes coulissantes intérieures.

Montage und Wartungshandbuch für Schiebetürantriebe.

Manual para ensamblaje, instalación y manutención para automatizar puertas correderas interiores.

Manual de instalação e manutenção para automação de portas corrediças interiores.



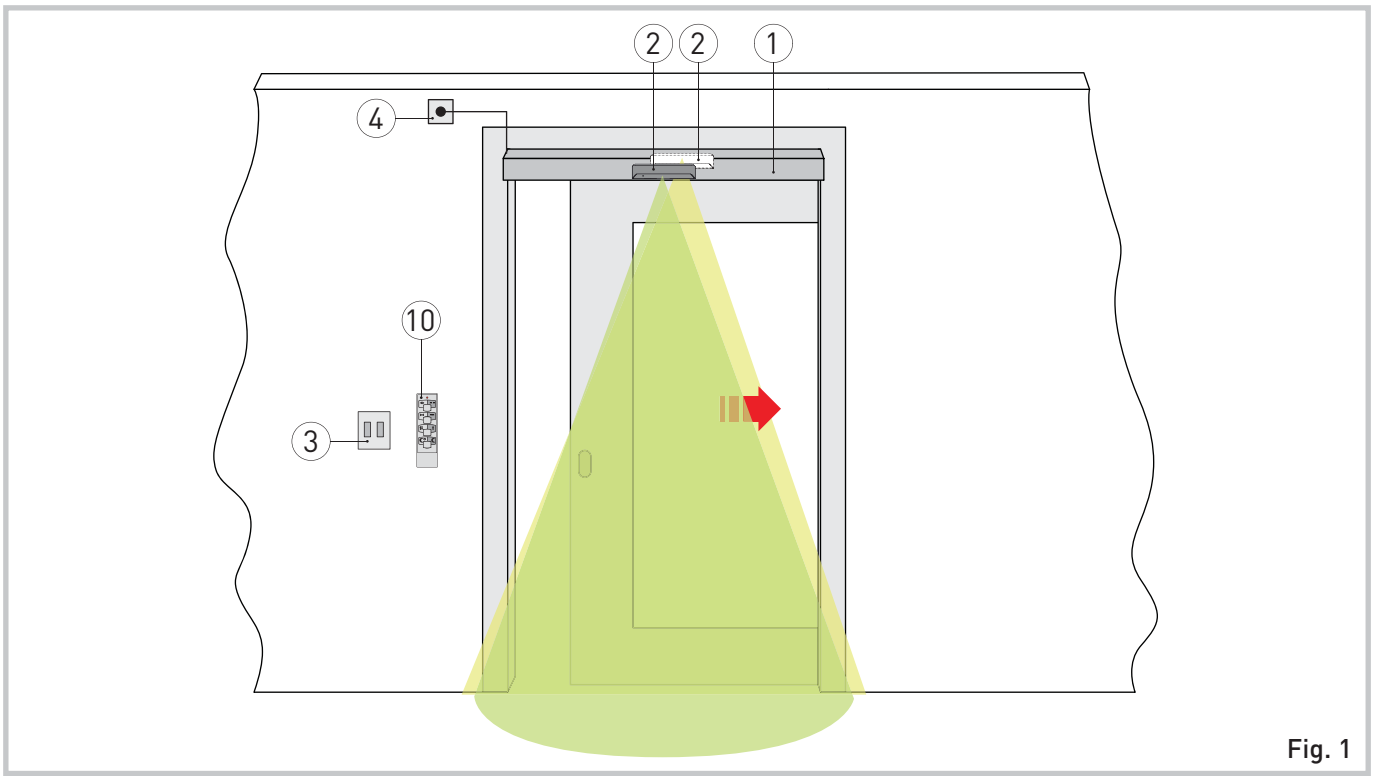

Fig. 1

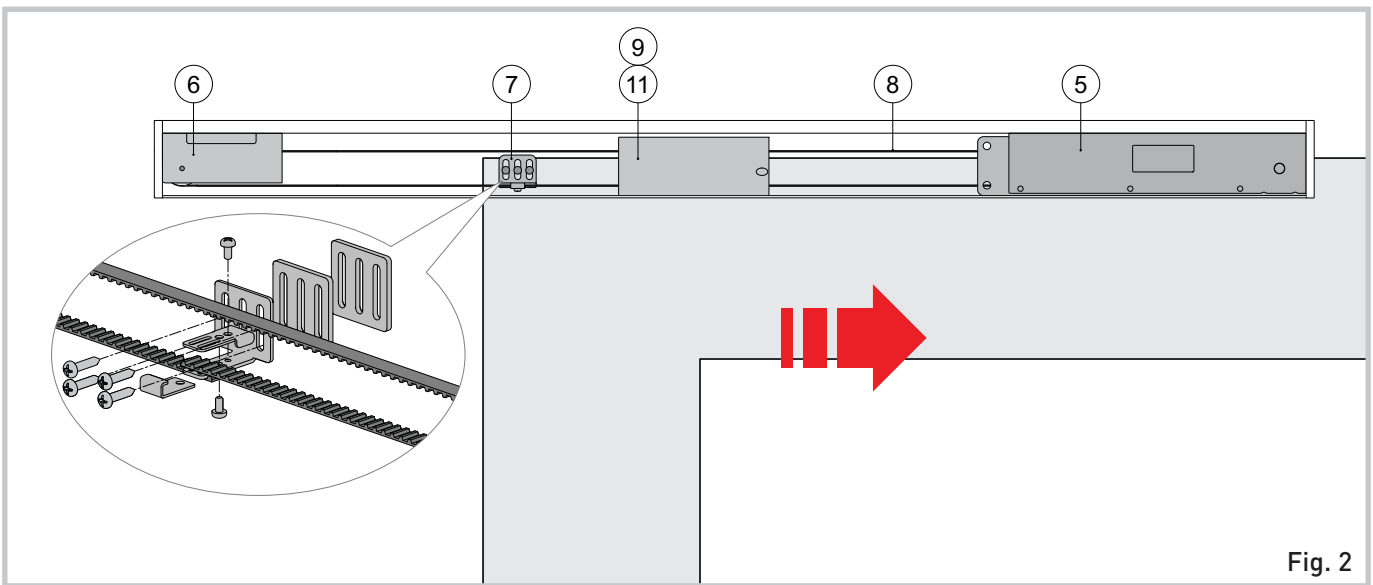

Fig. 2

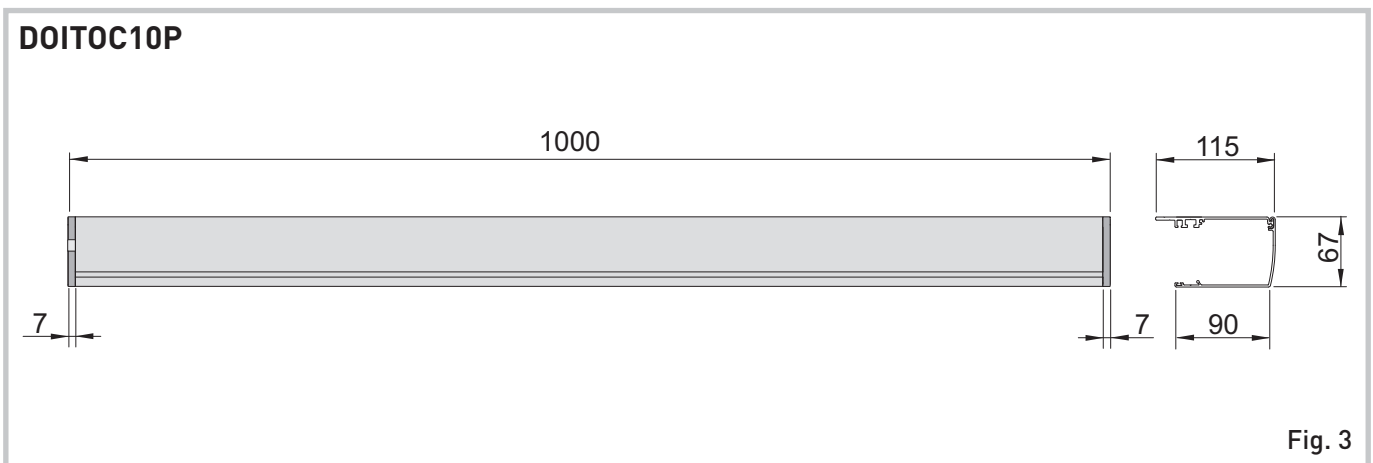

Fig. 3

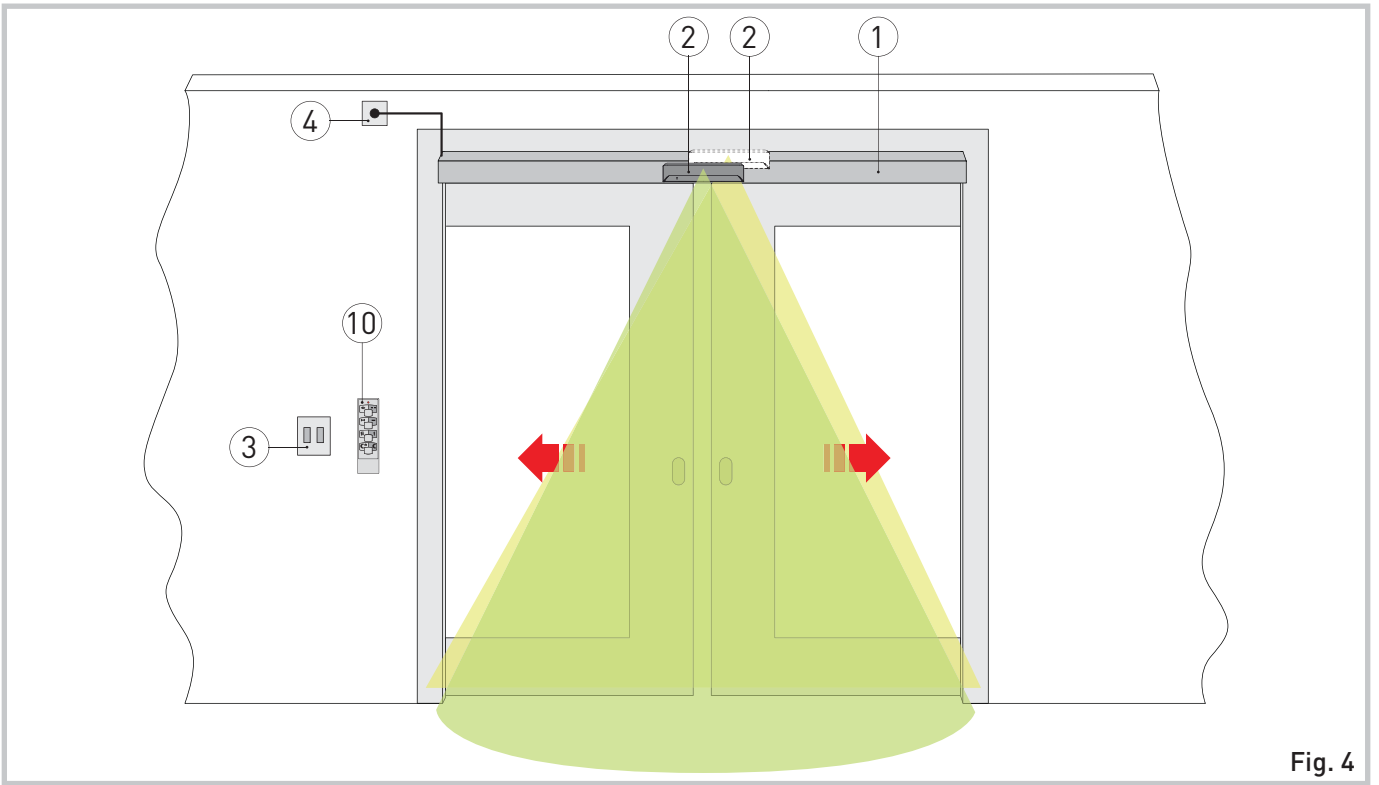

Fig. 4

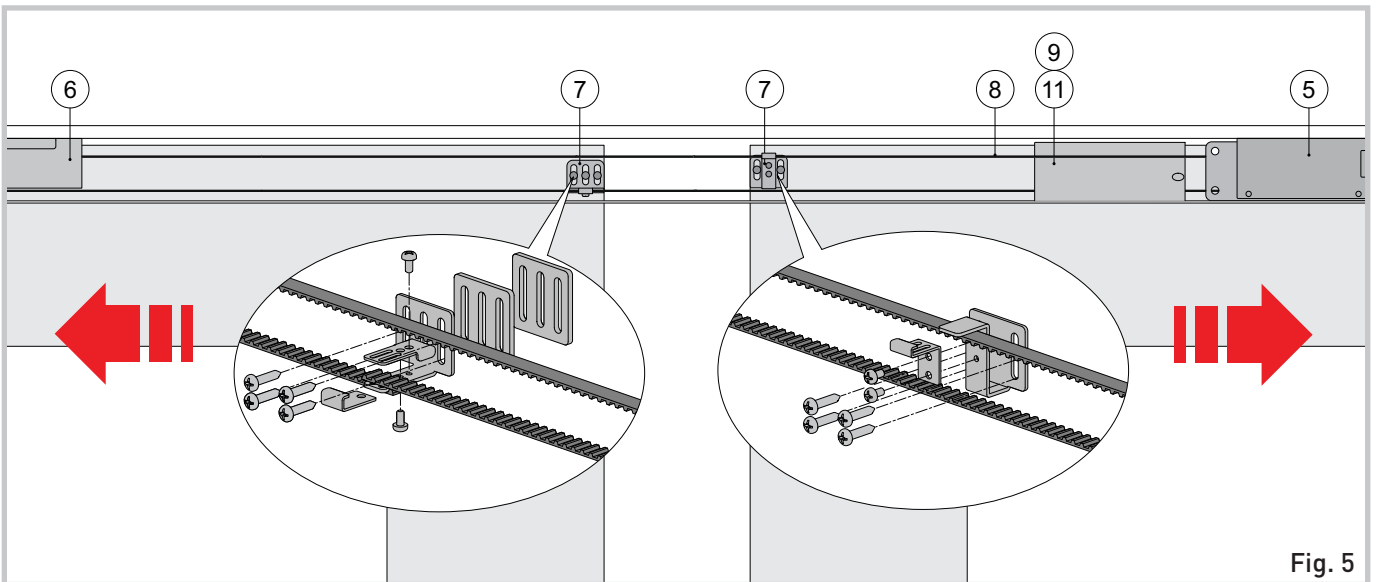

Fig. 5

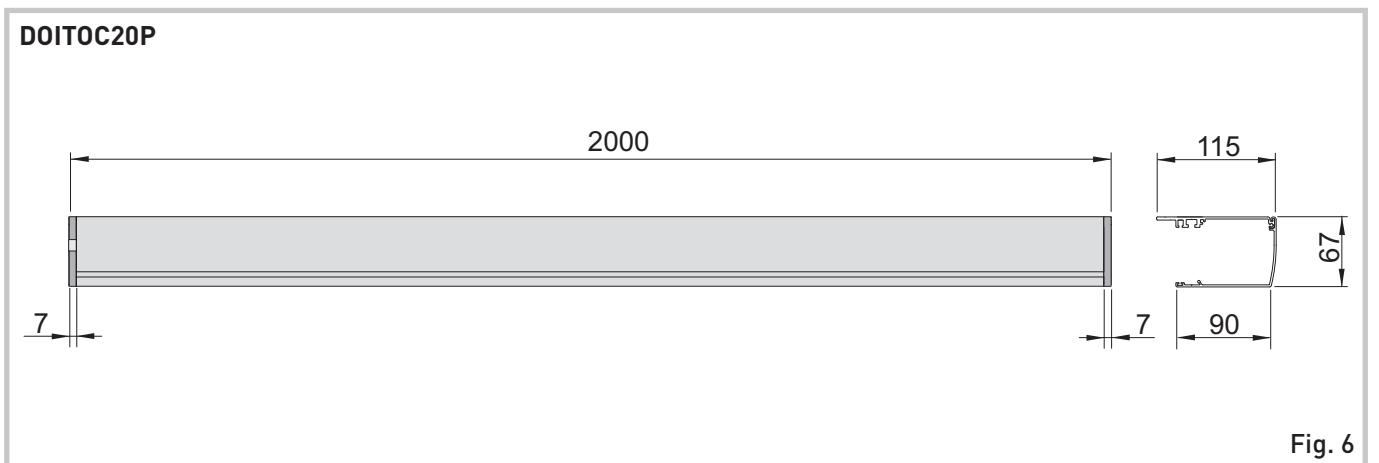

Fig. 6

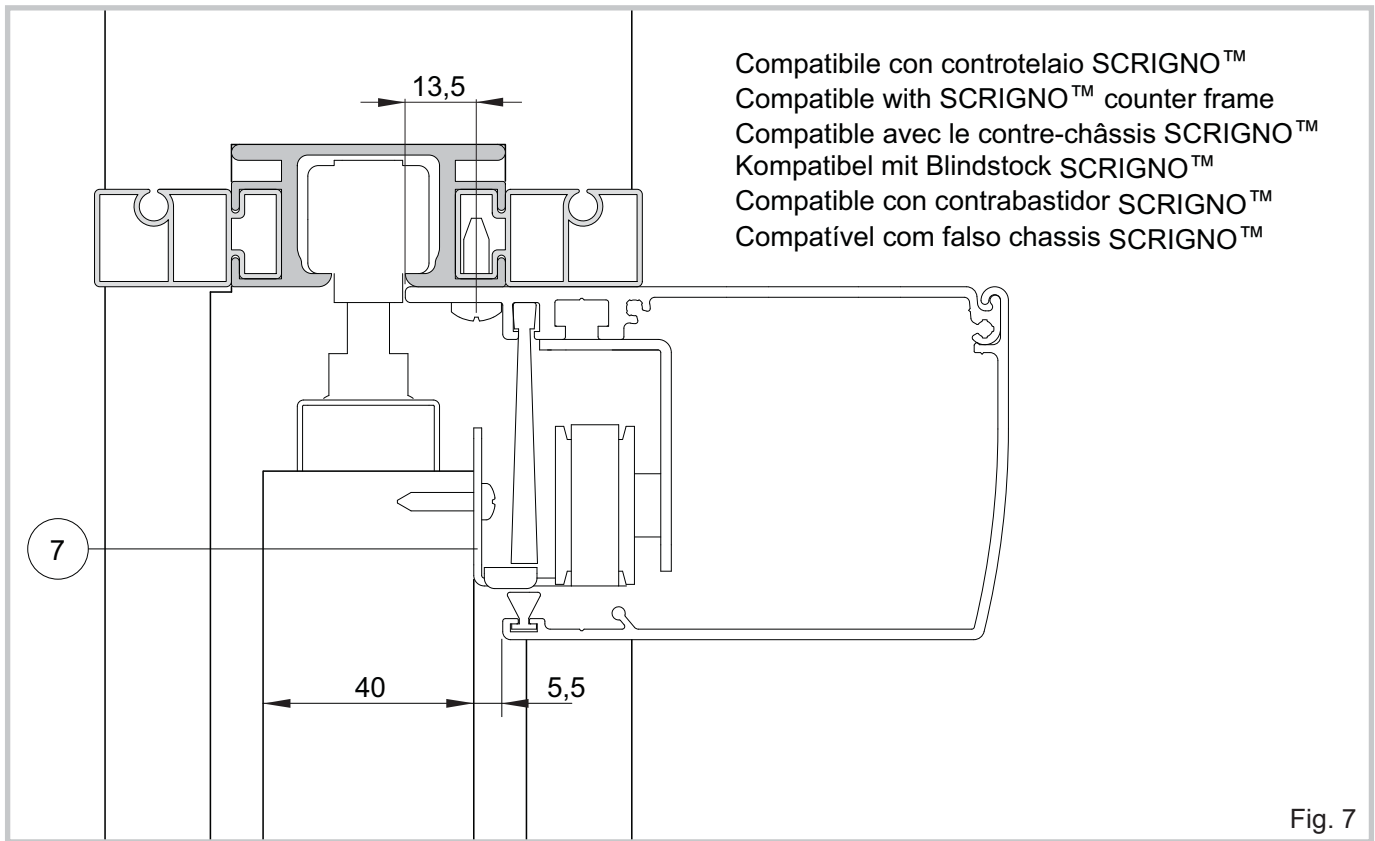

Fig. 7

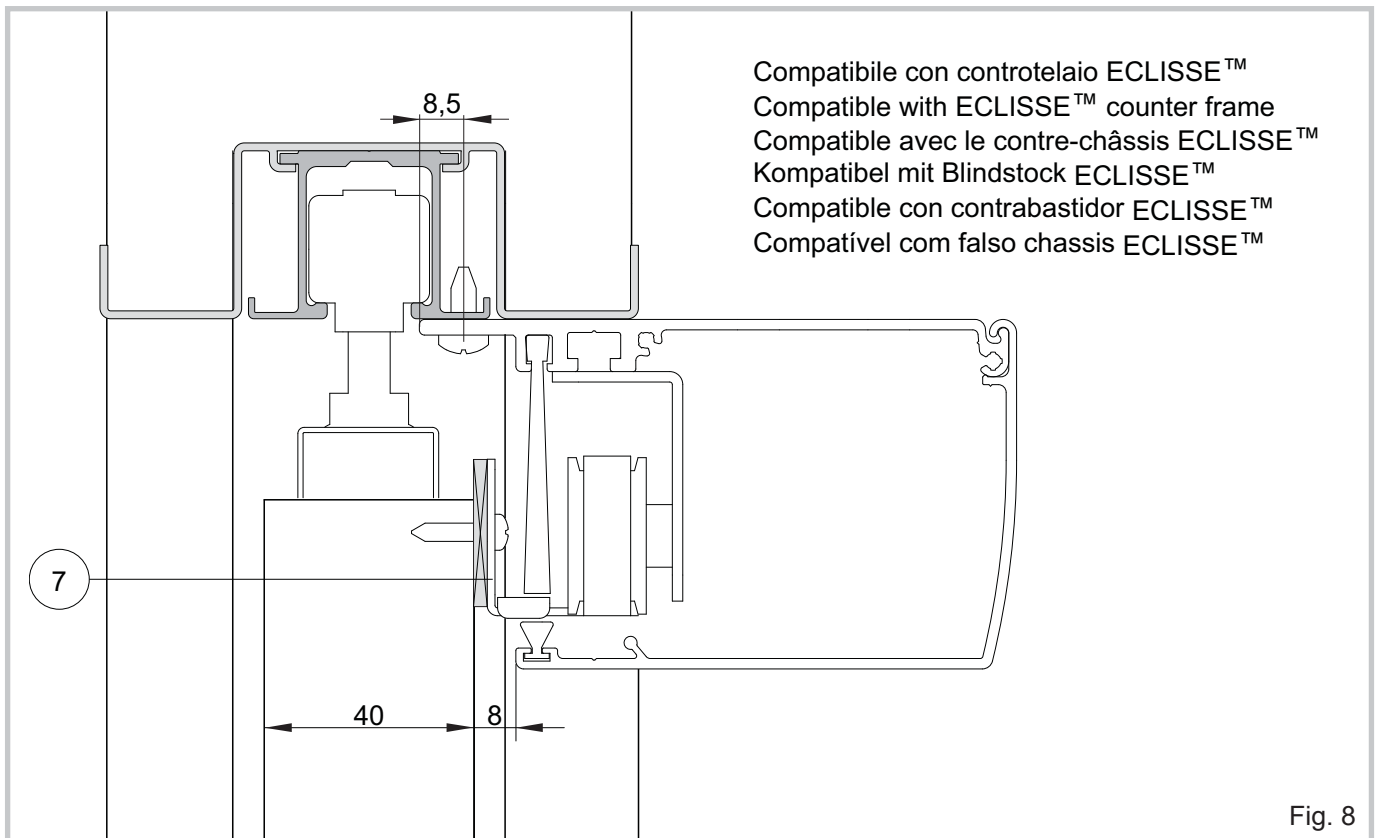

Fig. 8

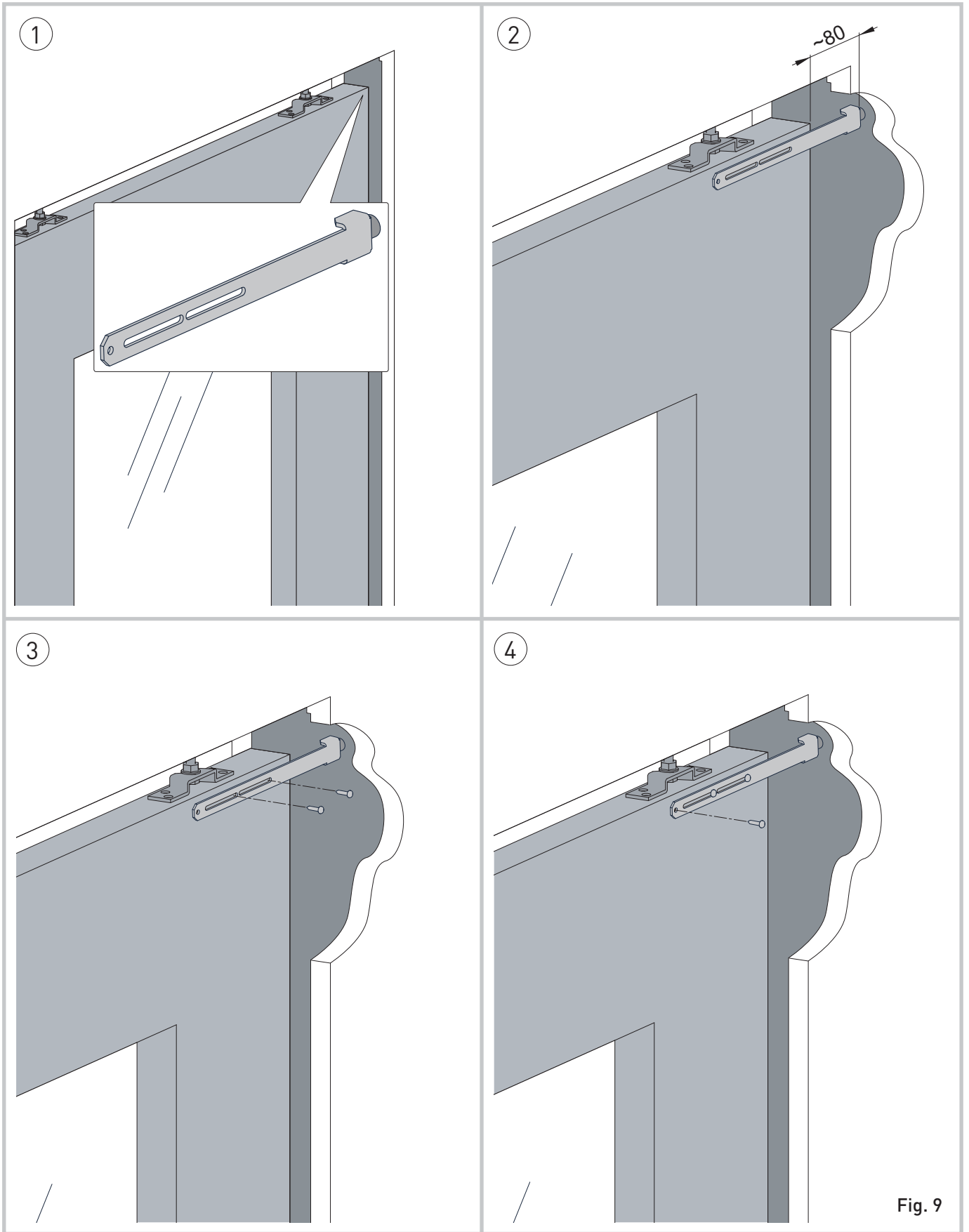

Fig. 9

Avvertenze generali per la sicurezza



La mancata osservanza delle informazioni contenute nel presente manuale può dare luogo a infortuni personali o danni all'apparecchio.
Conservate le presenti istruzioni per futuri riferimenti

Il presente manuale di installazione è rivolto esclusivamente a personale qualificato. L'installazione, i collegamenti elettrici e le regolazioni devono essere effettuati nell'osservanza della Buona Tecnica e in ottemperanza alle norme vigenti.

Leggere attentamente le istruzioni prima di iniziare l'installazione del prodotto. Una errata installazione può essere fonte di pericolo.

 I materiali dell'imballaggio (plastica, polistirolo, ecc.) non vanno dispersi nell'ambiente e non devono essere lasciati alla portata dei bambini in quanto potenziali fonti di pericolo.

Prima di iniziare l'installazione verificare l'integrità del prodotto.

Non installare il prodotto in ambiente e atmosfera esplosivi: presenza di gas o fumi infiammabili costituiscono un grave pericolo per la sicurezza.

Prima di installare la motorizzazione, apportare tutte le modifiche strutturali relative alla realizzazione dei franchi di sicurezza ed alla protezione o segregazione di tutte le zone di schiacciamento, cesoiamento, convogliamento e di pericolo in genere.

Verificare che la struttura esistente abbia i necessari requisiti di robustezza e stabilità. Il costruttore della motorizzazione non è responsabile dell'inosservanza della Buona Tecnica nella costruzione degli infissi da motorizzare, nonché delle deformazioni che dovessero intervenire nell'utilizzo.

I dispositivi di sicurezza (fotocellule, coste sensibili, stop di emergenza, ecc.) devono essere installati tenendo in considerazione: le normative e le direttive in vigore, i criteri della Buona Tecnica, l'ambiente di installazione, la logica di funzionamento del sistema e le forze sviluppate dalla porta motorizzata.

I dispositivi di sicurezza devono proteggere eventuali zone di schiacciamento, cesoiamento, convogliamento e di pericolo in genere, della porta motorizzata.

Applicare le segnalazioni previste dalle norme vigenti per individuare le zone pericolose.

Ogni installazione deve avere visibile l'indicazione dei dati identificativi della porta motorizzata. Quando richiesto, collegare la porta motorizzata ad un efficace impianto di messa a terra eseguito come indicato dalle vigenti norme di sicurezza.

 Durante gli interventi di installazione, manutenzione e riparazione, togliere l'alimentazione prima di aprire il coperchio per accedere alle parti elettriche.

La rimozione del carter di protezione dell'automazione deve essere eseguita esclusivamente da personale qualificato.

 La manipolazione delle parti elettroniche deve essere effettuata munendosi di bracciali conduttivi antistatici collegati a terra.

Il costruttore della motorizzazione declina ogni responsabilità qualora vengano installati componenti incompatibili ai fini della sicurezza e del buon funzionamento.

Per l'eventuale riparazione o sostituzione dei prodotti dovranno essere utilizzati esclusivamente ricambi originali.

L'installatore deve fornire tutte le informazioni relative al funzionamento automatico, manuale e di emergenza della porta motorizzata, e consegnare all'utilizzatore dell'impianto le istruzioni d'uso.

Dichiarazione di Incorporazione delle quasi macchine

Noi:

Entrematic Group AB
Lodjursgatan 10
SE-261 44 Landskrona
Sweden

dichiariamo sotto la nostra responsabilità che i seguenti tipi di apparecchiatura:

Ditec CIVIK, Ditec OLLY C

Sono conformi alle seguenti direttive:

2014/30/UE	Direttiva Compatibilità Elettromagnetica (EMCD)
2006/42/CE	Direttiva Macchine (MD), relativamente ai seguenti requisiti essenziali di salute e sicurezza: 1.1.2, 1.2.1, 1.2.2, 1.2.3, 1.2.4.2, 1.2.6, 1.3.9, 1.4.3, 1.7.2, 1.7.4, 1.7.4.1, 1.7.4.2
2011/65/UE	sulla restrizione dell'uso di determinate sostanze pericolose nelle apparecchiature elettriche ed elettroniche (RoHS)

Documentazione tecnica relativa all'integrazione sicura fornita.

Norme europee armonizzate applicate:

EN 60335 -1:2012+A11:2014	EN ISO 13849 -1:2015	EN 61000-6-1:2007	EN 61000-3-3:2013
EN 60335-2-103:2015	EN 16005:2012/AC:2015	EN 61000 -6-3:2007+A1:2011	EN 61000-3-2:2014

Il processo di produzione è volto ad assicurare la conformità dell'attrezzatura alla documentazione tecnica.

L'apparecchiatura non deve essere messa in servizio finché il sistema porta finale installato non è stato dichiarato conforme alla Direttiva Macchine 2006/42/CE dall'installatore.

Responsabile del fascicolo tecnico:

Matteo Fino E-mail: matteo.fino@entrematic.com

Entrematic Group AB
Lodjursgatan 10
SE -261 44 Landskrona
Sweden

Luogo
Landskrona

Data
2020-09-02

Firma
Matteo Fino

Posizione
Presidente Entrance Automation

1. DATI TECNICI

Alimentazione	230V~ / 50-60 Hz
Assorbimento	0.2A
Alimentazione accessori	24V= / 0.36A
Spinta	30N
Velocità in apertura*	0.4m/s
Velocità in chiusura	0.2m/s
Intermittenza	S2= 20min, S3= 30%
Portata massima	40kg (1 anta), 55kg (2 ante)
Dimensioni	115 x 67 x 1000 [DOITOC10P] , 115 x 67 x 2000 [DOITOC20P]
Corsa max	910mm [DOITOC10P], 1860mm [DOITOC20P]
Temperatura	-20°C / +55°C
Grado di protezione	IP20



*La velocità massima dell'anta varia a seconda del peso anta se utilizzo il servizio LOW ENERGY (Vedi capitolo 6)

2. INDICAZIONI DI UTILIZZO

Utilizzo: INTENSO. Ditec Olly C è progettata per essere installata su guide commerciali per porte a scomparsa. Rappresenta la soluzione estetica per rendere automatiche le porte scorrevoli residenziali.

3. RIFERIMENTI ILLUSTRAZIONI

La garanzia di funzionamento e le prestazioni dichiarate si ottengono solo con accessori e dispositivi di sicurezza DITEC.

3.1 Riferimenti installazione tipo (fig. 1-4)

- [1] Attuatore
- [2] Sensore combinato per apertura e sicurezza in chiusura
- [3] Pulsantiera
- [4] Alimentazione
- [10] COMGTC - Selettore di funzioni wireless (rif. COMGC)

3.2 Riferimenti automazione (fig. 2-5)

- [5] Motoriduttore con quadro elettronico
- [6] Rinvio
- [7] Staffa attacco anta
- [8] Cinghia
- [9] OCL - Ricevitore radio
- [11] COMGRC - Ricevitore selettore di funzioni wireless (rif. COMGC)

4. INSTALLAZIONE

Tutte le misure riportate sono espresse in millimetri (mm), salvo diversa indicazione.



Suggerimenti generali / problemi di sicurezza

Evitare intrappolamenti tra l'anta in movimento e le parti fisse circostanti dovuti al movimento di apertura della porta. Le seguenti distanze sono considerate sufficienti ad evitare intrappolamenti per le parti del corpo identificate;

- per le dita, una distanza maggiore di 25mm e inferiore a 8mm
- per piede, una distanza superiore a 50mm
- per la testa, una distanza superiore a 300mm
- e per l'intero corpo, una distanza superiore a 500mm

Se queste distanze non possono essere rispettate è necessaria una protezione.

- I punti di pericolo devono essere protetti fino a un'altezza di 2,5mm dal livello del pavimento.
- L'automatismo non deve essere utilizzato con un gruppo porte che incorpori una porta pedonale.
- L'interruttore elettrico deve essere posizionato nella vista diretta della parte azionata ma lontano dalle parti in movimento. A meno che non sia azionato da chiave, deve essere installato ad un'altezza minima di 1,5m e non accessibile al pubblico.

4.1 Fissaggio cassonetto

- Se necessario accorciare la lunghezza del cassonetto (lato rinvio) alla misura del vano passaggio della porta.

ATTENZIONE: dopo il taglio riposizionare correttamente i componenti nel cassonetto. La puleggia di rinvio [6] e la puleggia del motoriduttore [5] devono essere a ridosso delle testate. Tendere la cinghia [8] in modo adeguato.

- Fissare il cassonetto alla guida superiore della porta come indicato in fig. 7 (modello Scigno) oppure in fig. 8 (modello Eclisse).

4.2 Fissaggio anta

- Portare l'anta in posizione di chiusura.
- Avvicinare il più possibile la staffa attacco anta [7] alla puleggia e fissarla all'anta come indicato in fig. 7-8.

ATTENZIONE: se lo spessore della porta è diverso da 40mm usare adeguati spessori.

ATTENZIONE: in caso di automazione a due ante le staffe attacco anta devono essere posizionate a filo anta come indicato in fig. 5.

- Aprire e chiudere manualmente la porta verificando il corretto scorrimento dell'anta.

ATTENZIONE: aprire completamente l'anta e verificare che la staffa attacco anta [7] non vada a sbattere contro la puleggia.

4.3 Fissaggio staffa fermobattuta

Per un corretto funzionamento è necessario fermare l'anta scorrevole circa 90mm prima del completo incasso in posizione di apertura. Fissare quindi la staffa fermobattuta in dotazione come indicato in fig.9.

- La staffa fermobattuta può essere fissata indifferentemente sia sul lato interno che sul lato esterno della porta. Scegliere la posizione più idonea.
- Chiudere completamente la porta e fissare la staffa fermobattuta mediante le asole presenti senza stringere le viti.
- Aprire la porta fino alla battuta e lasciandone ~90 mm in luce.
- Richiudere completamente la porta, stringere le viti e fissare permanentemente la staffa fermobattuta mediante una terza vite su foro non asolato.

4.4 Installazione del ricevitore radio OCL

È possibile installare il ricevitore radio che consente l'attivazione della porta mediante comandi senza cavi di collegamento.

- Fissare il ricevitore radio [9] all'interno del cassonetto mediante le viti in dotazione.
- Effettuare i collegamenti elettrici come indicato nel relativo manuale.
- Memorizzare i trasmettitori come indicato nel relativo manuale.

4.5 Installazione del selettore di funzioni COMGC

È possibile installare il selettore radio che consente la selezione delle funzioni della porta senza cavi di collegamento:

- Fissare il ricevitore [11] COMGRC all'interno del cassonetto mediante le viti in dotazione.
- Effettuare i collegamenti elettrici come indicato nel relativo manuale.
- Memorizzare il trasmettitore [10] COMGTC come indicato nel relativo manuale.

5. COLLEGAMENTI ELETTRICI

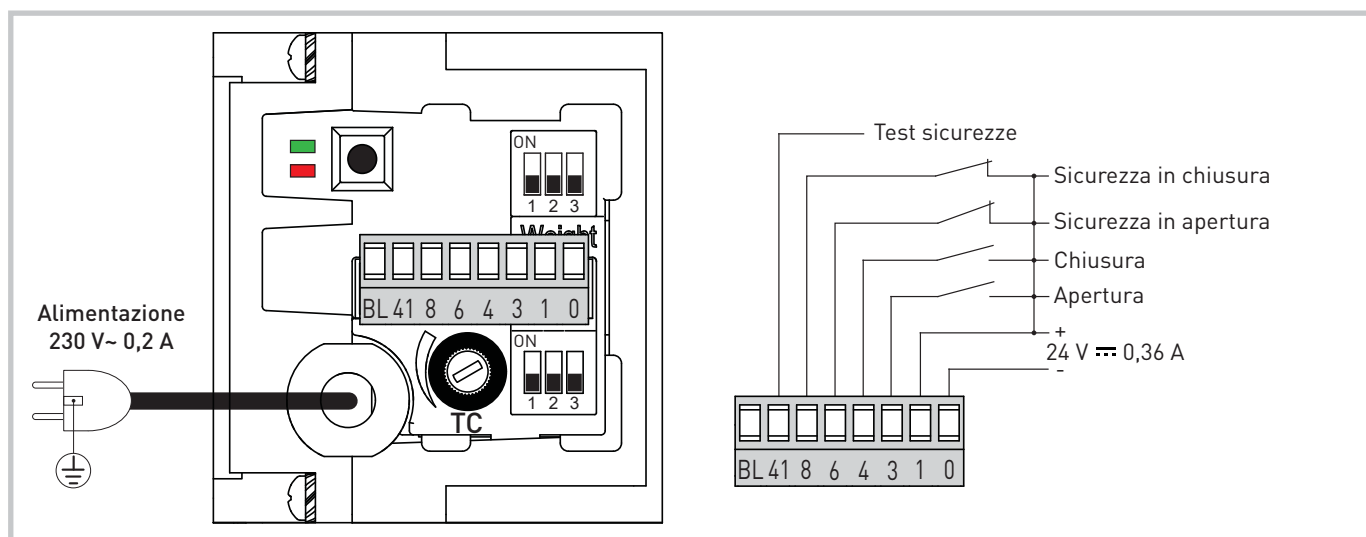

-Sezione max del filo utilizzabile su singolo morsetto = 1,3 mm² (26AWG).

-Se vengono utilizzati fili con un diametro maggiore o più fili, effettuare un collegamento esterno tramite apposito morsetto (non fornito).

5.1 Comandi

Comando	Funzione	Descrizione
1 — 3	N.O. APERTURA	La chiusura del contatto attiva la manovra di apertura.
1 — 4	N.O. CHIUSURA	La chiusura del contatto attiva la manovra di chiusura.
1 — 3 1 — 4	N.O. STOP	La concomitanza di un comando apre e di un comando chiude effettua l'arresto di qualsiasi movimento. ATTENZIONE: alla riapertura del contatto la porta riprende la manovra interrotta.
1 — 6	N.C. NON UTILIZZATO	Ponticellare contatto 1-6 se il DIP 3 =OFF, ponticellare contatto 41-6 se DIP3= ON.
1 — 8	N.C. SICUREZZA IN CHIUSURA	L'apertura del contatto provoca l'inversione del movimento (riapertura) durante la fase di chiusura. NB: Se non viene utilizzata nessuna sicurezza in chiusura e DIP3= ON, si deve ponticellare il contatto 41-8.
41 — (+) 0 — (-)	N.C. TEST SICUREZZE	Mediante il morsetto 41 viene attivato un test del dispositivo di sicurezza ad ogni ciclo. Se il test fallisce il led ROSSO lampeggia brevemente e il test viene ripetuto. Con DIP3=ON collegare i morsetto 41 e 0 del quadro elettronico ai corrispondenti morsetti di test presenti sul dispositivo di sicurezza. Se i dispositivi di sicurezza non sono testati vedere descrizione DIP3=OFF.

5.2 Uscite e accessori



Uscita	Valore - Accessori	Descrizione
	24V ~ 0,36A	Alimentazione accessori. Uscita per alimentazione accessori esterni.
		NON UTILIZZARE

5.3 Regolazioni



PROCEDURA ABILITAZIONE REGOLAZIONE TRIMMER/DIP SWITCHES





I trimmer e i dip switches influenzano la funzione di sicurezza di limitazione delle forze. La loro regolazione deve essere eseguita nel modo indicato (in caso contrario le modifiche non saranno accettate e sarà segnalato dal lampeggio dei LED ROSSO e VERDE):

- Durante la fase di programmazione l'automazione si arresta e non è possibile effettuare dei comandi.
- Premere il pulsante  per 4 s (LED VERDE e ROSSO accesi);
- Procedere alla regolazione dei trimmer e dei Dip switches entro il tempo limite di 5 min;
- Per terminare la procedura premere il pulsante per 2 s, l'automazione prosegue la manovra precedentemente interrotta.

	Descrizione	OFF 	ON 
	DIP1 Spinta in chiusura. Mantiene l'anta in posizione di chiusura.	Disabilitata.	Abilitata.
	DIP2 Selezione senso di marcia. Il senso di apertura va considerato guardando l'automazione dal lato ispezionabile.	Apertura a destra. Automazione a 2 ante.	Apertura a sinistra.
	DIP3 Safety test morsetto 41	Disabilitato. I sensori di sicurezza non sono monitorati e i contatti N.C. devono essere collegati ai morsetti 1-6 e 1-8.	Abilitata.

TC 	Tempo di chiusura automatica. Da 0 a 30 s. Regola il tempo che intercorre tra la fine della manovra di apertura e l'inizio della chiusura automatica. Con porta aperta un comando apre rinnova il conteggio. Se si desidera escludere la chiusura automatica, regolare TC al massimo.
--	---

	Descrizione	OFF 	ON 
DIP "WEIGHT" 	Selezione peso anta per utilizzo LOW ENERGY	Vedere capitolo 6	Vedere capitolo 6

LED	Acceso	Lampeggiante
Verde 	Presenza di alimentazione	Encoder non funzionante oppure anomalia automazione.
Rosso 	Contatto di sicurezza 6 o 8 aperti.	Fallimento del test di sicurezza.
Rosso + Verde 	Abilitata procedura regolazione trimmer/Dip switches.	<ul style="list-style-type: none"> • 2 lampeggi = conferma regolazione trimmer, Dip switches. • 4 lampeggi a intervalli di 1 s, indica che si è effettuata una regolazione senza aver prima abilitato procedura regolazione: rieseguire procedura abilitazione.
Rosso / Verde 		Lampeggiante alternatamente l'automazione è ferma per concomitanza di un comando di apertura e di un comando di chiusura.

















	Apertura: Una breve pressione attiva la manovra di apertura
	ABILITAZIONE regolazione trimmer/Dip-switches: (led rosso+verde accesi, vedi procedura abilitazione)

6. REQUISITI DELLE PORTE PER UTILIZZO LOW ENERGY

L'automazione OLLY C viene fornita di fabbrica con impostazione di massime prestazioni. Se viene utilizzata con servizio Low Energy è necessario selezionare i dip switch "Weight" in relazione al peso dell'anta, come indicato nella seguente tabella.

NB: considerare il peso di una singola anta.

Attenzione: una impostazione sbagliata dei dip switch rispetto al peso porta comporta una non corretta velocità e conseguente funzionamento non coerente con utilizzo Low Energy.

					
DIP "WEIGHT"			Peso di una anta	Velocità apertura	Prestazione
OFF 	OFF 	OFF 	Fino a max 40kg (1 anta) o 2 x 27kg (2 ante)	0,40m/s	Massime prestazioni, NO Low Energy
ON 	OFF 	OFF 	Fino a 25kg	0,36m/s	Prestazioni Low Energy
OFF 	ON 	OFF 	Da 26 → 30kg	0,34m/s	
ON 	ON 	OFF 	Da 31 → 35kg	0,31m/s	
OFF 	OFF 	ON 	Da 36 → 40kg	0,29m/s	

					
DIP "WEIGHT"			Peso di una anta	Velocità chiusura	Prestazione
Qualsiasi configurazione			Fino a max 40kg (1 anta) o 2 x 27kg (2 ante)		Prestazioni Low Energy

7. ESEMPI DI COLLEGAMENTO

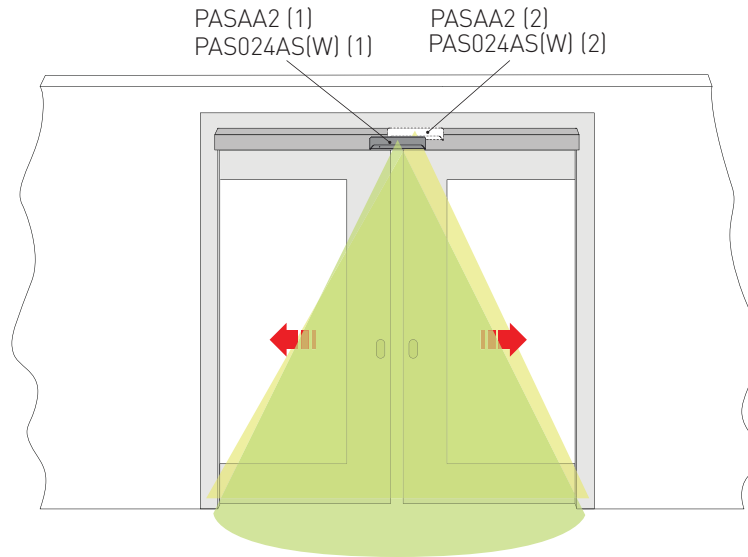

7.1 Nessun sensore di sicurezza

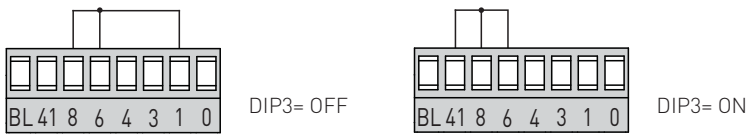

7.2 Sensori di apertura e sicurezza (1 e 2)

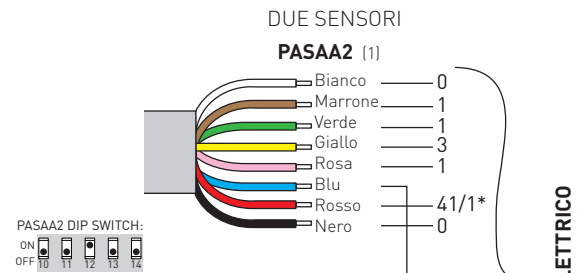
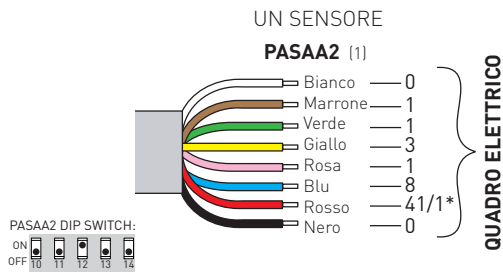

i * Collegare a 41 se DIP3= ON; collegare a 1 se DIP3= OFF

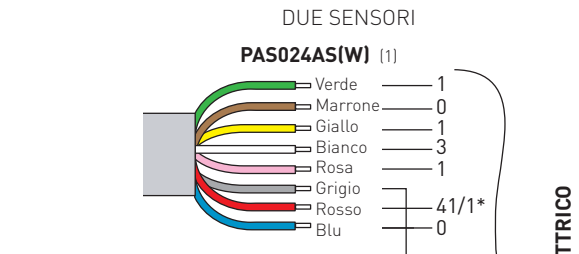
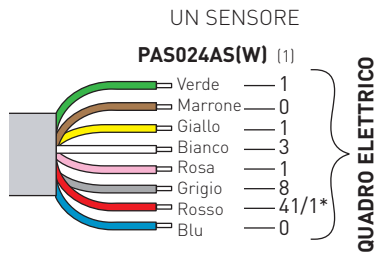

i * Collegare a 41 se DIP3= ON; collegare a 1 se DIP3= OFF

8. AVVIAMENTO

- Collegare gli accessori;
- Ponticellare i contatti di sicurezza 1-8 e 1-6 (41-8 e 41-6 se DIP3= ON) sul quadro elettrico se non utilizzati;
- Collegare l'alimentazione di rete all'automazione;
- Abilitare la regolazione trimmer/dip switches (vedi paragrafo 5.3);
- Selezionare i dip 1, 2, 3 e il trimmer TC in base al funzionamento desiderato (vedi paragrafo 5.3);
- Selezionare dip "weight " 1, 2, 3 in base al peso anta se si desidera utilizzare l'automazione con prestazioni LOW ENERGY (Vedi paragrafo 6).

ATTENZIONE: ad ogni accensione il quadro elettrico esegue un RESET automatico ed il primo movimento di apertura o chiusura viene eseguito a bassa velocità e permette l'apprendimento automatico delle posizioni di battuta [acquisizione].

- Controllare il corretto funzionamento della porta con successivo comando apre.
- Verificare il funzionamento degli accessori collegati.
- Se l'automazione incontra un ostacolo durante la corsa di chiusura, lo rileva e si riapre. Se incontra un ostacolo durante la corsa di apertura, lo rileva e si arresta. Se l'ostacolo viene rilevato per tre volte consecutive, viene considerato come nuova battuta di arresto fino a quando non viene rimosso.
- L'automazione è dotata della funzione Push&Go/Pull&Close. Spingendo manualmente la porta, sia in apertura che in chiusura, si avvia la manovra motorizzata.



Se l'automazione non è alimentata, è possibile far scorrere le ante manualmente ma solo muovendole lentamente.

9. PIANO DI MANUTENZIONE ORDINARIA

Effettuare le seguenti operazioni e verifiche ogni 6 mesi, in base all'intensità di utilizzo dell'automazione.

Senza alimentazione 230V~:

- Pulire le parti in movimento (le guide di scorrimento dei carrelli).
- Controllare la tensione della cinghia.
- Pulire sensori di apertura e chiusura (se presenti).
- Controllare la stabilità dell'automatismo e verificare il serraggio di tutte le viti.
- Verificare il corretto allineamento dell'anta e la posizione delle battute.

Ridare alimentazione 230V~:

- Controllare la stabilità della porta e che il movimento sia regolare e senza attriti.
- Controllare il corretto funzionamento di tutte le funzioni di comando.
- Controllare il corretto funzionamento dei sensori di apertura e chiusura (se presenti).
- Verificare che l'installazione sia conforme alle norme vigenti e ai requisiti essenziali imposti dalle autorità competenti.



NOTA: per le parti di ricambio fare riferimento al listino ricambi.



Per l'eventuale riparazione o sostituzione dei prodotti dovranno essere utilizzati esclusivamente ricambi originali.

L'installatore deve fornire tutte le informazioni relative al funzionamento automatico, manuale e di emergenza dell'automazione, e consegnare all'utilizzatore dell'impianto le istruzioni d'uso.

L'installatore deve redigere il registro di manutenzione, nel quale dovrà indicare tutti gli interventi di manutenzione ordinaria e straordinaria effettuati.

General safety precautions



Failure to respect the information given in this manual may cause personal injury or damage to the device.
Keep these instructions for future reference

This assembly and installation manual is intended exclusively for the use of qualified personnel. Installation, electrical connections and adjustments must be performed by qualified personnel, in accordance with Good Working Methods and in compliance with the current regulations. Read the instructions carefully before installing the product.

Incorrect installation could be dangerous.



The packaging materials (plastic, polystyrene, etc.) should not be discarded in the environment or left within reach of children, as they are a potential source of danger.

Before installing the product, make sure it is in perfect condition.

Do not install the product in explosive areas and atmospheres: the presence of inflammable gas or fumes represents a serious safety hazard.

Before installing the motorisation device, make all the necessary structural modifications to create safety clearance and to guard or isolate all the crushing, shearing, trapping and general hazardous areas.

Make sure the existing structure is up to standard in terms of strength and stability. The motorisation device manufacturer is not responsible for failure to observe Good Working Methods when building the frames to be motorised, or for any deformations during use.

The safety devices (photocells, safety edges, emergency stops, etc.) must be installed taking into account the applicable laws and directives, Good Working Methods, installation premises, system operating logic and the forces developed by the motorised door or gate.

The safety devices must protect against crushing, cutting, trapping and general danger areas of the motorised door or gate.

Display the signs required by law to identify hazardous areas.

Each installation must bear a visible indication of the data identifying the motorised door or gate. When necessary, connect the motorised door or gate to an effective earthing system that complies with the current safety standards.



During installation, maintenance and repair operations, cut off the power supply before opening the cover to access the electrical parts.

The automation protection casing must be removed by qualified personnel only.



The electronic parts must be handled using earthed antistatic conductive arms. The manufacturer of the motorisation device declines all responsibility if component parts not compatible with safe and correct operation are fitted.

Only use original spare parts when repairing or replacing products.

The installer must supply all information concerning the automatic, manual and emergency operation of the motorised door or gate, and must provide the user with the operating instructions.

Declaration of incorporation of partly completed machinery

Nous :

Entrematic Group AB
Lodjursgatan 10
SE-261 44 Landskrona
Sweden

declare under our responsibility that the following types of equipment:

Ditec CIVIK, Ditec OLLY C

comply with the following directives:

2014/30/EU Electromagnetic Compatibility Directive (EMCD)
2006/42/EC Machinery Directive (MD) for the following essential health and safety requirements:
1.1.2, 1.2.1, 1.2.2, 1.2.3, 1.2.4.2, 1.2.6, 1.3.9, 1.4.3, 1.7.2, 1.7.4, 1.7.4.1, 1.7.4.2
2011/65/EU on the restriction of the use of certain hazardous substances in electrical and electronic equip-
ment (RoHS)

Technical documentation for safe integration supplied.

Harmonised European standards which have been applied:

EN 60335 -1:2012+A11:2014	EN ISO 13849 -1:2015	EN 61000-6-1:2007	EN 61000-3-3:2013
EN 60335-2-103:2015	EN 16005:2012/AC:2015	EN 61000 -6-3:2007+A1:2011	EN 61000-3-2:2014

The production process aims to guarantee that the equipment complies with the technical documentation.

The equipment must not be put into service until the final door system installed has been declared compliant with the Machinery Directive 2006/42/EC by the installer.

Person in charge of technical data sheet:

Matteo Fino E-mail : matteo.fino@entrematic.com

Entrematic Group AB
Lodjursgatan 10
SE-261 44 Landskrona
Sweden

Place	Date	Signature	Position
Landskrona	2020-09-02	Matteo Fino 	Entrance Automation President

1. TECHNICAL DETAILS

Power supply	230V~ / 50-60 Hz
Absorption	0.2A
Accessories power supply	24V= / 0.36A
Thrust	30N
Opening speed*	0.4m/s
Closing speed	0.2m/s
Intermittence	S2= 20min, S3= 30%
Max door weight	40kg (1 wing), 55kg (2 wings)
Dimensions	115 x 67 x 1000 [DOITOC10P], 115 x 67 x 2000 [DOITOC20P]
Max run	910mm [DOITOC10P], 1860mm [DOITOC20P]
Temperature	-20°C / +55°C
Degree of protection	IP20



*The maximum door wing speed varies according to the door wing weight if the LOW ENERGY service is used (See chap. 6)

2. OPERATING INSTRUCTIONS

Applications: INTENSE. Ditec Olly C it is designed to be installed on commercial concealed door guides. The aesthetic solution to make residential sliding doors automatic.

3. REFERENCE TO ILLUSTRATIONS

The given operating and performance features can only be guaranteed with the use of DITEC accessories and safety devices.

3.1 Standard installation references (fig. 1-4)

- [1] Actuator
- [2] Combined sensor for opening and safe closing
- [3] Push-button panel
- [4] Power supply
- [10] COMGTC - Wireless functions selector switch (ref. COMGC)

3.2 Automation references (fig. 2-5)

- [5] Gearmotor with control panel
- [6] Transmission
- [7] Door wing connection bracket
- [8] Belt
- [9] OCL - Radio receiver
- [11] COMGRC - Wireless functions selector switch receiver (ref. COMGC)

4. INSTALLATION



General tips / Safety concerns

Ensure that entrapment between the driven part and the surrounding fixed parts due to the opening movement of the driven part is avoided. The following distances are considered sufficient to avoid entrapments for the parts of the body identified:

- for fingers, a distance greater than 25mm or less than 8mm;
- for feet, a distance greater than 50mm;
- for heads, a distance greater than 300mm;
- and for the whole body, a distance greater than 500mm.

If these distances can not be met, protection is necessary:

- Danger points shall be safeguarded up to a height of 2.5m from the floor level.
- The operator shall not be used with a doorset incorporating a wicket door.
- The electrical switch must be positioned in the direct view of the driven part but away from the moving parts. Unless operated by a key, it must be installed at a minimum height of 1.5 m and not accessible to the public.

Unless otherwise specified, all measurements are expressed in millimeters (mm).

4.1 Case fastening

- If necessary shorten the length of the case (transmission side) to the dimension of the door passage opening.

ATTENTION: reposition the components correctly inside the case after cutting. The transmission pulley [6] and the gearmotor pulley [5] must be behind the heads. Suitably tension the belt [8].

- Fix the case to the upper guide of the door as shown in fig. 7 (Scrigno model) or in fig 8 (Eclisse model).

4.2 Door wing fastening

- Place the door wing in the closure position.
- Position the door wing connection bracket [7] as close as possible to the pulley and fix it to the door wing as shown in fig. 7-8.

ATTENTION: if the thickness of the door is different from 40mm, use suitable spacers that are not supplied.

ATTENTION: the door wing connection brackets for double door automations must be positioned flush with the door as shown in fig. 5.

- Aprire e chiudere manualmente la porta verificando il corretto scorrimento dell'anta.

ATTENTION: open the door wing completely and check that the connection bracket [7] does not hit against the pulley.

4.3 Close stop fastening

For correct working, it is necessary to stop the sliding door wing about 90mm before it reaches the fully opened position. Fasten the close stop bracket (supplied) as shown in fig.9.

- The close stop bracket can be fastened on the inner or outer side of the door. Choose the most suitable position.
- Close the door completely and fasten the close stop bracket using the slots, without tightening the screws.
- Open the door as far as the stop, leaving ~90mm within the doorway.
- Close the door completely, tighten the screws, and permanently fasten the close stop bracket using a third screw on the non-slotted hole.

4.4 Installation of the radio receiver OCL

It is possible to install the radio receiver that allows the door to be activated by means of wireless commands.

- Fasten the radio receiver [9] inside the box by means of the supplied screws.
- Carry out the electrical connections as shown in the related manual.
- Memorise the transmitters as shown in the related manual.

4.5 Installation of COMGC functions selector switch

The radio selector which allows you to select door functions can be installed using wireless commands:

- Fasten the COMGRC receiver [11] inside the box using the supplied screws.
- Carry out the electrical connections as described in the relevant manual.
- Memorise the COMGTC transmitter [10] as described in the relevant manual.

5. ELECTRICAL CONNECTIONS

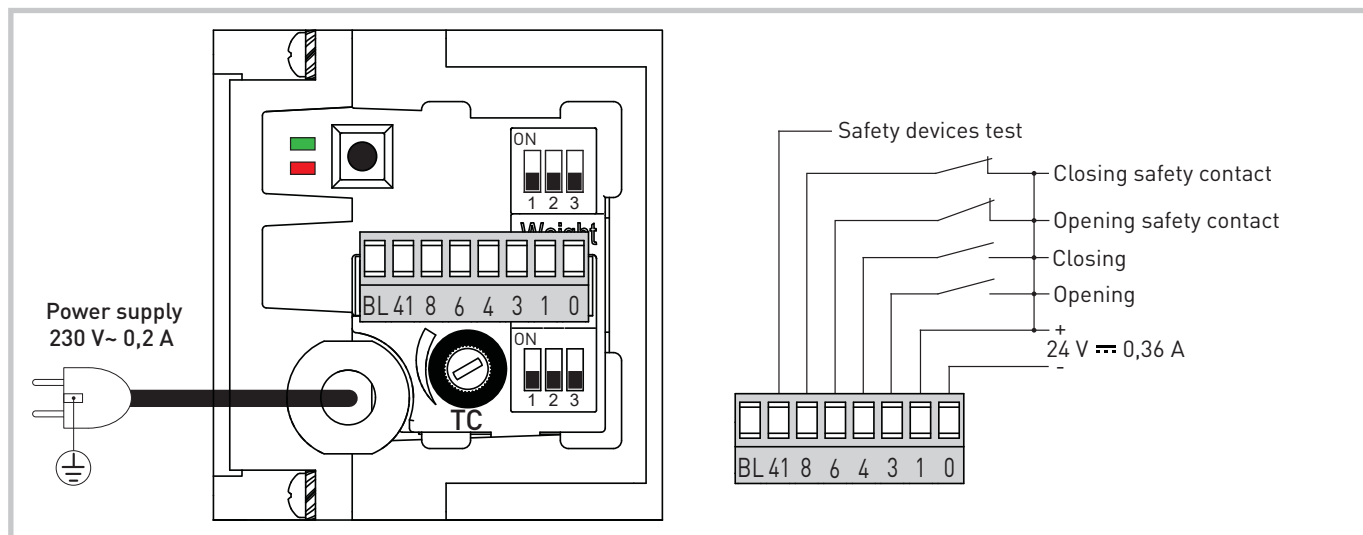

- i** -Max section of the wire that can be used on a single clamp = 1.3 mm² [26AWG].
- If used wires with a larger diameter or more wires, make an external connection using a special terminal (not supplied).

5.1 Commands

Command	Funzione	Descrizione
1 — 3	N.O. OPENING	The opening manoeuvre starts when the contact is closed.
1 — 4	N.O. CLOSING	The closing manoeuvre starts when the contact is closed.
1 — 3 1 — 4	N.O. STOP	The coincidence of an opening and closing command stops all movements. WARNING: when the contact opens again the door proceeds with the interrupted manoeuvre.
1 — 6	N.C. NOT USED	Make a jumper on contact 1-6 if DIP 3 =OFF, make a jumper on contact 41-6 if DIP 3 =ON.
1 — 8	N.C. CLOSING SAFETY CONTACT	The opening of the contact reverses the movement (re-opening) during the closing operation. NB: If no closing safety device is used and DIP3= ON, a jumper must be made on contacts 41-8.
41 — (+) 0 — (-)	N.C. SAFETY DEVICES TEST	Terminal 41 activates a test of the safety device on each cycle. If the test fails the RED LED flashes briefly and the test is repeated. With DIP3=ON connect terminal 41 and 0 of the control panel to the corresponding test terminals on the safety device. If the safety devices are not tested, see description DIP3=OFF.

5.2 Output and accessories



Output	Value - Accessories	Description
	24V DC 0,36A	Accessories power supply. Power supply output for external accessories.
		DO NOT USE

5.3 Adjustments



TRIMMER/DIP SWITCHES ADJUSTMENT ENABLING PROCEDURE





The trimmers and DIPs affect the force limiting safety function. They must be set as instructed, (if not, the modifications will not be accepted and the RED and GREEN LEDs will flash):

- During the setting phase, the operator stops and it is not possible to carry out commands.
- Press the button  for 4 s (RED and GREEN LEDs on);
- Adjust the trimmers and DIP switches within the 5-minute time limit;
- To complete the procedure, press the button for 2 s, the operator continues the previously interrupted operation

	Description	OFF 	ON 
	DIP1 Closure thrust. Maintain the door wing in the closure position.	Disabled.	Enabled
	DIP2 Direction selection. The opening direction is intended by viewing the automation from the side being examined.	Righthand opening. Automation with 2 door wings	Lefthand opening
	DIP3 Safety test terminal 41	Disabled The safety sensors are not monitored and the NC contacts must be connected to terminals 1-6 and 1-8	Enabled

TC		Automatic closing time. From 0 to 30 s. Adjust the time that passes between the end of the opening operation and the start of the automatic closing operation. The count is reset when an opening command is given with the door open. Adjust the TC to the maximum if automatic closing is not required.
-----------	---	--

	Description	OFF 	ON 
DIP "WEIGHT" 	Select wing weight for LOW ENERGY use	See chapter 6	See chapter 6

LED	Acceso	Flashing light
Green 	Power supply on	Encoder not working or automation faulty.
Red 	Safety contacts 6 or 8 open.	Safety test failure.
Red + Green 	Trimmer/dip switches adjustment procedure enabling	<ul style="list-style-type: none"> • 2 flashes = trimmer/dip switches adjustment confirmed • 4 flashes at 1s intervals, indicates that an adjustment has been made without first enabling the adjustment procedure;perform the enabling procedure again.
Red + Green 		Alternately flashing light the automation is stopped due to coinciding opening and closing commands

















	Opening: Press quickly to activate the opening operation
	ENABLING of trimmer/dip switches adjustment: (red+green LEDs on, see enabling procedure)

6. REQUISITES FOR DOORS FOR LOW ENERGY USE

The OLLY C automation is factory supplied with maximum performance setting. If used with the Low Energy service, the "Weight" dip switches must be selected according to the weight of the door wing, as shown in the following table.

NB: consider the weight of a single door wing.

Attention: an incorrect setting of the dip with respect to the weight of the door leads to an incorrect speed and consequent operation inconsistent with Low Energy use.

					
DIP1	DIP2	DIP3	Weight of a door wing	Opening speed	Performance
OFF 	OFF 	OFF 	Up to a max 40kg (1 door) or 2 x 27kg (2 doors)	0,40m/s	Maximum performance, NO Low Energy
ON 	OFF 	OFF 	Up to 25kg	0,36m/s	Low energy performance
OFF 	ON 	OFF 	From 26 → 30kg	0,34m/s	DO NOT USE
ON 	ON 	OFF 	From 31 → 35kg	0,31m/s	
OFF 	OFF 	ON 	From 36 → 40kg	0,29m/s	

					
DIP1	DIP2	DIP3	Weight of a door wing	Closing speed	Performance
Any configuration			Up to a max 40kg (1 door) or 2 x 27kg (2 doors)	0,20m/s	Low Energy performance

7. CONNECTION EXAMPLES

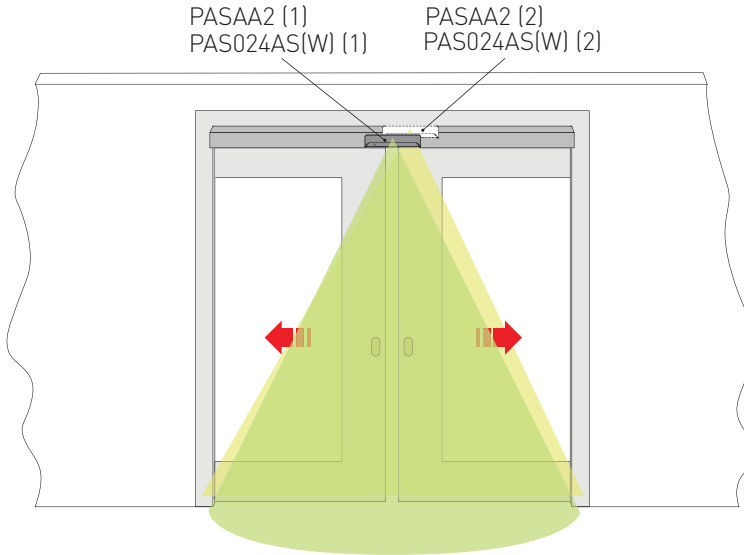

7.1 No safety sensor

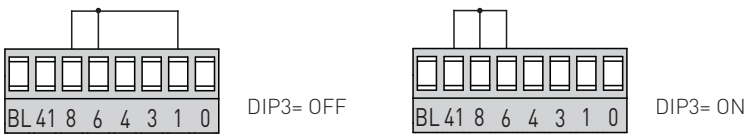

7.2 Opening and safety sensors (1 and 2)

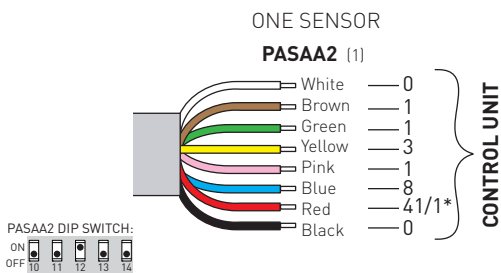

i * Connect to 41 if DIP3= ON; connect at 1 if DIP3= OFF

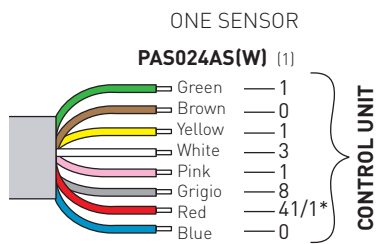
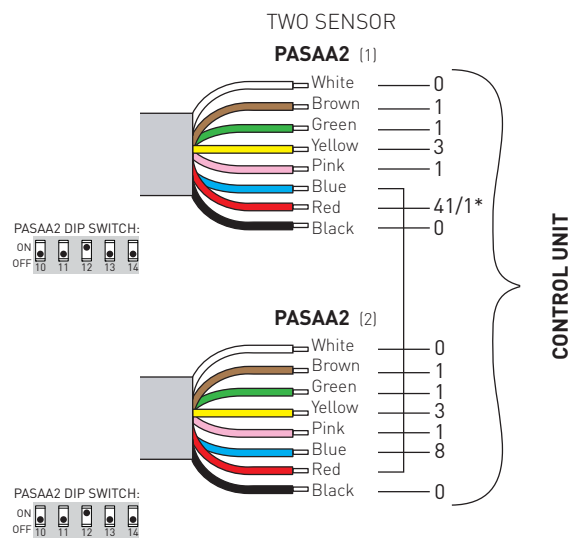

i * Connect to 41 if DIP3= ON; connect at 1 if DIP3= OFF

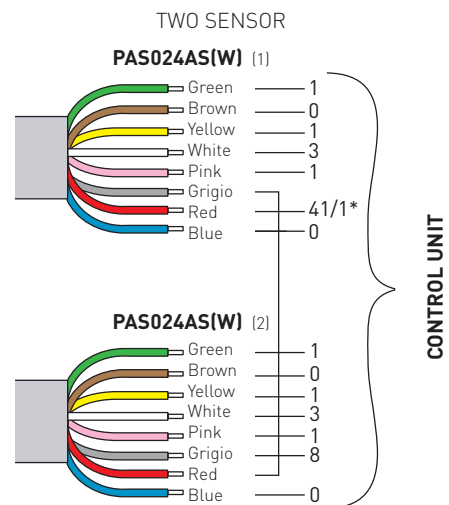

8. START-UP

- Connect the accessories;
- Make a jumper on the safety contacts 1-8 and 1-6 (41-8 and 41-6 if DIP3= ON) on the control panel if not used;
- Reconnect the mains power supply to the automation;
- Enable the trimmer/dip switches adjustment (See paragraph 5.3);
- Select dips 1, 2, 3 and the trimmer TC based on the desired operation (See paragraph 5.3);
- Select dip "weight " 1, 2, 3 based on the wing weight if you want to use the automation with LOW ENERGY performance (see paragraph 6).

WARNING: the control panel performs an automatic RESET on each start and the first opening or closing manoeuvre is performed at low speed allowing the automatic self-learning of the stop positions (acquisition).

- Check that the door is operating correctly with a further opening command.
- Check the operation of the connected accessories.
- If the automation encounters an obstacle during closure, it is detected and the automation opens again. If the automation encounters an obstacle during opening, it is detected and the automation stops. If the obstacle is detected three times consecutively, it is considered as the new stop until it is removed.
- The automation is equipped with the Push&Go/Pull&Close function. The motorised opening or closing operation is activated when the door is pushed.



If the automation is not powered, it is possible to slide the doors manually but only by moving them slowly.

9. ROUTINE MAINTENANCE PLAN

Perform the following operations and checks every 6 months, according to the intensity of use of the automation.

Without 230V~ power:

- Clean the moving parts (the carriage guides).
- Check the belt tension.
- Clean the opening and closing sensors (if present).
- Check the stability of the automatic system and make sure that all screws are correctly tightened.
- Check the alignment of the door wing and the stop position.

Turn on the 230V~ power:

- Check the stability of the door, and make sure it moves smoothly.
- Check that all control functions are operating correctly.
- Make sure the opening and closing sensors are working correctly (if present).
- Make sure the installation complies with the current regulations and the essential requisites laid down by the relevant authorities.



NOTE: for spare parts, see the spares price list.



Only use original spare parts for repairing or replacing products.

The installer must supply all information concerning the automatic, manual and emergency operation of the motorised automation or gate, and must provide the user with the operating instructions.

The installer must prepare and keep a maintenance record showing all the routine and extraordinary maintenance work carried out.

Consignes générales de sécurité



Le non-respect des informations contenues dans le présent manuel peut entraîner des blessures corporelles ou endommager l'appareil. Conserver les présentes instructions pour de futures consultations

Le manuel d'assemblage et d'installation est destiné uniquement au personnel qualifié. L'installation, les raccordements électriques et les réglages doivent être effectués par un personnel qualifié selon les règles de la bonne technique et conformément aux normes en vigueur. Lire les instructions avec beaucoup d'attention avant d'installer le produit. Une mauvaise installation peut être source de danger.

 Les matériaux qui composent l'emballage (plastique, polystyrène, etc.) ne doivent pas être abandonnés dans la nature ni laissés à la portée des enfants car ils représentent des risques de danger.

Avant de commencer l'installation contrôler l'intégrité du produit.

Ne jamais installer le produit dans un milieu de travail ou une atmosphère explosive : la présence de gaz ou de fumées inflammables représente un grave danger pour la sécurité.

Avant d'installer la motorisation, effectuer toutes les modifications structurelles nécessaires à l'installation des dispositifs de sécurité, à la protection et à la séparation de toutes les zones avec risque d'écrasement, cisaillement entraînement et danger en général.

Contrôler si la structure existante est suffisamment solide et stable. Le fabricant de la motorisation n'est pas responsable de la non-observation des règles de la bonne technique en ce qui concerne la construction des portes et des portails à motoriser, ainsi que des déformations qui pourraient se produire lors de l'utilisation.

Les dispositifs de sécurité (cellules photoélectriques, bourrelets sensibles, arrêts d'urgence, etc.) doivent être installés en tenant compte des règlements et des directives en vigueur, des règles de bonne technique, de l'environnement de l'installation, de la logique de fonctionnement du système et des forces développées par la porte motorisée.

Les dispositifs de sécurité doivent protéger toutes les zones éventuelles des risques d'écrasement, cisaillement, entraînement et danger en général de la porte ou du portail motorisé.

Appliquer les signalisations prévues par les normes en vigueur pour indiquer les zones dangereuses.

Chaque installation doit indiquer de manière visible les données d'identification de la porte ou du portail motorisé.

Si nécessaire, relier la porte ou les portails motorisés à une installation de mise à la terre efficace effectuée comme indiqué par les normes de sécurité en vigueur.

 Durant les interventions d'installation, entretien et réparation, couper l'alimentation avant d'ouvrir le couvercle pour accéder aux pièces électriques.

Le retrait du carter de protection de l'automatisme doit être effectué exclusivement par un personnel qualifié.

 Pour la manipulation des pièces électriques porter des bracelets conducteurs antistatiques reliés à terre. Le fabricant de la motorisation décline toute responsabilité pour toute installation de composants incompatibles du point de vue de la sécurité et du bon fonctionnement. Pour l'éventuelle réparation ou remplacement des produits, seules des pièces de rechange originales devront être utilisées.

L'installateur doit fournir à l'utilisateur toutes les informations relatives au fonctionnement automatique, manuel et d'urgence de la porte ou du portail motorisés, de même que le mode d'emploi de l'installation.

Déclaration d'incorporation des quasi-machines

Nous :
Entrematic Group AB
Lodjursgatan 10
SE-261 44 Landskrona
Sweden

déclare sous sa responsabilité que les types d'appareils reportés ci-dessous :

Ditec CIVIK, Ditec OLLY C
Sont conformes aux directives suivantes :

2014/30/EU Directive compatibilité électromagnétique (EMCD)
2006/42/CE Directive Machines (MD) concernant les conditions essentielles de santé et de sécurité suivantes :
1.1.2, 1.2.1, 1.2.2, 1.2.3, 1.2.4.2, 1.2.6, 1.3.9, 1.4.3, 1.7.2, 1.7.4, 1.7.4.1, 1.7.4.2
2011/65/UE relative à la limitation de l'utilisation de certaines substances dangereuses dans les équipements
électriques et électroniques (RoHS)

Documentation technique relative à l'intégration sécurisée fournie.

Normes européennes harmonisées appliquées :

EN 60335 -1:2012+A11:2014	EN ISO 13849 -1:2015	EN 61000-6-1:2007	EN 61000-3-3:2013
EN 60335-2-103:2015	EN 16005:2012/AC:2015	EN 61000 -6-3:2007+A1:2011	EN 61000-3-2:2014

Le processus de fabrication est destiné à assurer la conformité de l'équipement à la documentation technique.

L'appareil ne doit pas être mis en service tant que le système de porte final installé n'a pas été déclaré conforme à la Directive Machines 2006/42/CE par l'installateur.

Responsable du dossier technique :

Matteo Fino Courriel : matteo.fino@entrematic.com

Entrematic Group AB
Lodjursgatan 10
SE-261 44 Landskrona
Sweden

Place
Landskrona

Date
2020-09-02

Signature
Matteo Fino

Position
Entrance Automation President

1. DONNÉES TECHNIQUES

Alimentation	230V~ / 50-60 Hz
Absorption	0.2A
Alimentation accessoires	24V= / 0.36A
Poussée	30N
Vitesse de ouverture*	0.4m/s
Vitesse de fermeture	0.2m/s
Intermittence	S2= 20min, S3= 30%
Portée maximale	40kg (1 vantail), 55kg (2 vantaux)
Dimensions	115 x 67 x 1000 [DOITOC10P], 115 x 67 x 2000 [DOITOC20P]
Course max	910mm [DOITOC10P], 1860mm [DOITOC20P]
Température	-20°C / +55°C
Degré de protection	IP20



*La vitesse maximale du vantail varie en fonction du poids si l'on utilise le service LOW ENERGY (voir le ch. 6)

2. MODE D'EMPLOI

Utilisation : INTENSE. La Ditec Olly C a été conçue pour une installation sur des guides du commerce pour des portes escamotables. Elle représente la solution esthétique pour l'automatisation des portes coulissantes résidentielles.

3. ELEMENTS ILLUSTRATIONS

La garantie de fonctionnement et les performances spécifiées ne s'obtiennent qu'avec les accessoires et les dispositifs de sécurité DITEC.

3.1 Références installation type (fig. 1-4)

- [1] Actionneur
- [2] Capteur combiné pour l'ouverture et la sécurité en fermeture
- [3] Tableau à pousoirs
- [4] Alimentation
- [10] COMGTC - Sélecteur de fonctions sans fil (ref. COMGC)

3.2 Références automatisme (fig. 2-5)

- [5] Motoréducteur avec tableau électronique
- [6] Renvoi
- [7] Bride de fixation du vantail
- [8] Courroie
- [9] OCL - Récepteur radio
- [11] COMGRC - Récepteur du sélecteur de fonctions sans fil (ref. COMGC)

4. INSTALLATION

Toutes les mesures sont indiquées en millimètre (mm), sauf indication contraire.



Conseils d'ordre général / Questions de sécurité

Veillez à éviter tout piégeage entre les pièces entraînées et les parties fixes environnantes du fait du mouvement d'ouverture de la pièce entraînée. Les distances suivantes sont considérées comme étant suffisantes pour éviter les coincements pour les parties du corps identifiées ;

- pour les doigts, une distance supérieure à 25mm ou inférieure à 8mm
- pour les pieds, une distance supérieure à 50mm
- pour les têtes, une distance supérieure à 300mm
- et pour le corps entier, une distance supérieure à 500mm

Si ces distances ne peuvent pas être respectées, une protection est nécessaire

- Les points de danger doivent être protégés jusqu'à une hauteur de 2,5m à partir du niveau du sol.
- L'opérateur ne doit pas être utilisé avec un ensemble de porte comprenant un portillon
- L'organe d'actionnement d'un interrupteur à polarisation d'arrêt doit être placé à la vue directe de la partie entraînée mais à l'écart des parties mobiles. À moins d'être actionné par clé, il doit être installé à une hauteur minimale de 1,5m et inaccessible au public;

4.1 Fixation caisson

- Si cela est nécessaire il faut raccourcir la longueur du caisson (côté renvoi) pour qu'elle corresponde à la grandeur de la baie de passage de la porte.

ATTENTION : après avoir effectué cette opération remettre en place les composants dans le caisson. La poulie de renvoi [6] et la poulie du motoréducteur [5] doivent se trouver contre les têtes. Tendre la courroie [8] de manière appropriée.

- Fixer le caisson au rail supérieur de la porte de la manière indiquée sur la fig. 7 (modèle Scigno) ou bien sur la fig. 8 (modèle Eclisse).

4.2 Fixation vantail

- Porter le vantail en position de fermeture.
- Rapprocher la bride de fixation du vantail le plus près possible [7] de la poulie et la fixer au vantail de la manière indiquée sur la fig. 7-8.

ATTENTION: si la porte a plus de 40mm d'épaisseurs il faut utiliser des épaisseurs appropriées qui ne font pas partie de notre fourniture.

ATTENTION: avec l'automatisme à deux vantaux les brides de fixation du vantail doivent être positionnées au raz du vantail comme indiqué sur la fig. 5.

- Ouvrir et fermer manuellement la porte en contrôlant le glissement du vantail.

ATTENTION: ouvrir complètement le vantail et contrôler si la bride de fixation du vantail [7] ne bute pas contre la poulie.

4.3 Fixation dispositif d'arrêt de butée

Pour obtenir un bon fonctionnement il faut arrêter le vantail coulissant environ 90mm avant qu'il ne s'encaisse complètement en position d'ouverture. Fixer donc la bride d'arrêt de butée fournie de la manière indiquée sur la fig. 9.

- La bride d'arrêt de butée peut être fixée aussi bien sur le côté interne que sur le côté externe de la porte. Choisir la meilleure position.
- Fermer complètement la porte et fixer la bride d'arrêt de butée avec les fentes présentes sans serrer les vis.
- Ouvrir la porte jusqu'à la butée et laisser ~90mm pour l'ouverture.
- Refermer complètement la porte, serrer les vis et fixer définitivement la bride d'arrêt de butée avec une troisième vis sur le trou sans la fente.

4.4 Fixation récepteur radiocommande OCL

Il est possible d'installer le récepteur de la radiocommande qui permet d'activer la porte avec des commandes sans fil de liaison.

- Fixer le récepteur de la radiocommande [9] à l'intérieur du caisson en utilisant les vis fournies.
- Effectuer les raccordements électriques en suivant les indications du manuel.
- Mémoriser les transmetteurs de la manière indiquée dans le manuel correspondant.

4.5 Installation du sélecteur de fonctions COMGC

On pourra installer le sélecteur radio permettant la sélection des fonctions de la porte sans câbles de raccordement :

- Fixer le récepteur [11] COMGRC à l'intérieur du caisson à l'aide des vis fournies.
- Effectuer les raccordements électriques comme indiqué dans le manuel correspondant.
- Mémoriser le transmetteur [10] COMGTC comme indiqué dans le manuel correspondant.

5. RACCORDEMENTS ÉLECTRIQUES

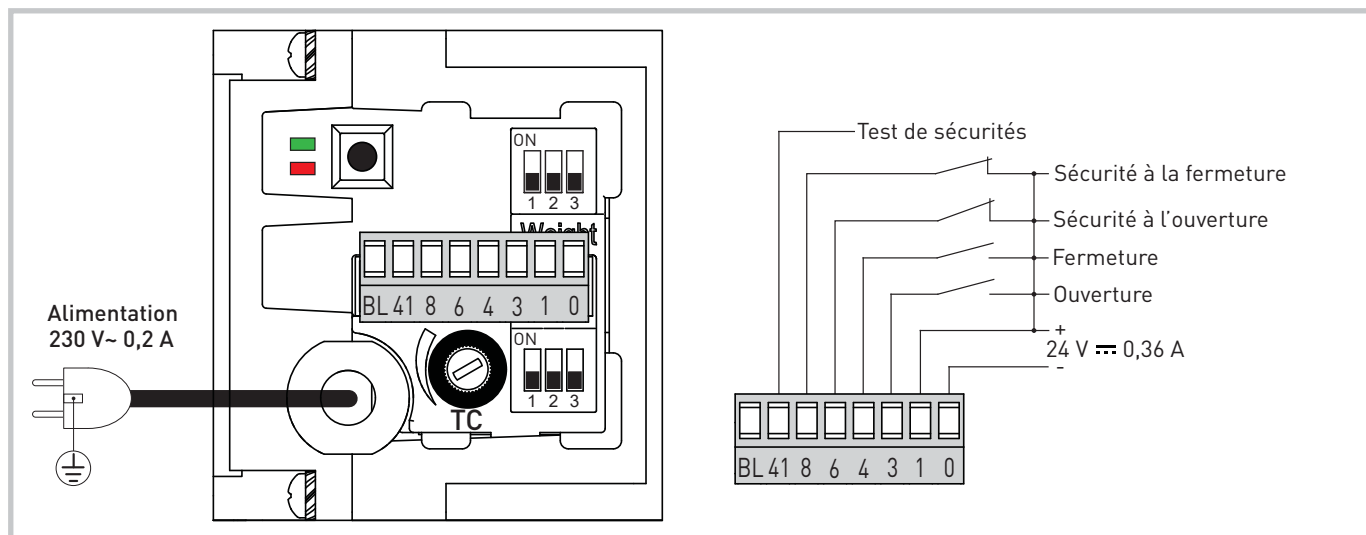

-Section maximale du fil pouvant être utilisée sur une seule pince = 1,3 mm² (26 AWG).

-Si vous utilisez des fils avec un diamètre supérieur ou plus, établissez une connexion externe à l'aide d'une borne spéciale (non fournie).

5.1 Commandes

Commande	Fonction	Description
1 — 3	N.O. OUVERTURE	La fermeture du contact active la manoeuvre d'ouverture.
1 — 4	N.O. FERMETURE	La fermeture du contact active la manoeuvre de fermeture.
1 — 3 1 — 4	N.O. STOP	La concomitance d'une commande ouvrir et d'une commande fermer provoque l'arrêt de n'importe quel mouvement. ATTENTION: lorsque le contact se rouvrir la porte recommence la manoeuvre interrompue.
1 — 6	N.C. NON UTILISÉ	Shunter le contact 1-6 si DIP 3 = OFF, shunter le contact 41-6 si DIP 3 = ON
1 — 8	N.C. SÉCURITÉ À LA FERMETURE	L'ouverture du contact entraîne l'inversion du mouvement (réouverture) lors de la phase de fermeture. N.B.: Si aucune sécurité en fermeture n'est utilisée et que DIP3 = ON, on doit shunter le contact 41-8.
41 — (+) 0 — (-)	N.C. TEST DES SÉCURITÉS	La borne 41 active un test du dispositif de sécurité à chaque cycle. Si le résultat du test est négatif, le VOYANT ROUGE clignote brièvement et le test est répété. Avec DIP3 = ON, raccorder les bornes 41 et 0 du tableau électronique aux bornes de test correspondantes du dispositif de sécurité. Si les dispositifs de sécurité ne sont pas testés, voir la description DIP3 = OFF.

5.2 Sorties et accessoires

Sortie	Valeur - Accessoires	Description
	24V ~ 0,36A	Alimentation des accessoires. Sortie pour alimentation accessoires externes.
		NE PAS UTILISER





5.3 Réglages

PROCÉDURE D'HABILITATION DU RÉGLAGE DES TRIMMERS ET DES INTERRUPTEURS DIP

Les trimmers et les interrupteurs DIP influent sur la fonction de sécurité de limitation des forces.



Leur réglage doit être exécuté de la manière indiquée (dans le cas contraire, les modifications ne seront pas acceptées et les VOYANTS ROUGE ET VERT clignoteront) :





- Pendant la phase de programmation, l'automatisme s'arrête et il n'est pas possible d'exécuter des commandes.
- Appuyer 4 s sur le bouton-poussoir  (VOYANTS VERT ET ROUGE allumés);
- Régler les trimmers et les interrupteurs DIP dans un délai limite de 5 min;
- Pour achever la procédure, appuyer 2 s sur le bouton-poussoir, l'automatisation continue l'opération précédemment interrompue.

	Description	OFF 	ON 
 DIP1 Spinta in chiusura. Maintient le vantail en position de fermeture.		Désactivée.	Activée
 DIP2 Sélection du sens de la marche. Le sens d'ouverture doit être considéré en regardant l'automatisme du côté où il peut être inspecté.		Ouverture à droite. Automatisme à 2 vantaux.	Ouverture à gauche
 DIP3 Test de sécurité de la borne 41		Désactivée. Les capteurs de sécurité ne sont pas suivis et les contacts NF doivent être raccordés aux bornes 1-6 et 1-8.	Activée



TC Temps de la fermeture automatique. De 0 à 30 s.
Règle le temps entre la fin de la manoeuvre d'ouverture et le début de la fermeture automatique.
Avec la porte ouverte, une commande d'ouverture remet le décompte à zéro.
Pour exclure la fermeture automatique, régler le TC au maximum.

	Description	OFF 	ON 
 DIP "WEIGHT"	Sélection du poids du vantail pour l'utilisation du service LOW ENERGY	Voir le chapitre 6	Voir le chapitre 6

VOYANT	Allumé	Clignotant
Vert 	Présence de l'alimentation	Encoder non funzionante oppure anomalia automazione.
Rouge 	Contact de sécurité 6 ou 8 ouvert.	Fallimento del test di sicurezza.
Rouge + Vert 	Habilite la procédure de réglage des trimmers et des interrupteurs DIP.	<ul style="list-style-type: none"> • 2 clignotements = confirmation du réglage des trimmers et des interrupteurs DIP. • 4 clignotements à intervalles de 1 s indiquent qu'un réglage a été effectué sans avoir tout d'abord habilité la procédure de réglage : exécuter de nouveau la procédure d'habilitation.
Rouge / Vert 		Clignotement alterné L'automatisme est à l'arrêt à cause d'une concomitance d'une commande d'ouverture et d'une commande de fermeture.



Ouverture
Une brève pression active la manoeuvre d'ouverture.

















HABILITATION au réglage des trimmers et des interrupteurs DIP
(voyants rouge et vert allumés, voir la procédure d'habilitation)

6. CONDITIONS REQUISES DES PORTES POUR L'UTILISATION AVEC LE SERVICE LOW ENERGY

L'automatisme OLLY C est imposé par défaut sur les performances maximales. S'il est utilisé avec le service Low Energy, il faudra sélectionner les interrupteurs DIP Weight en fonction du poids du vantail, comme indiqué dans le tableau suivant.

N.B. : prendre en compte le poids d'un simple vantail.

Attention. Un mauvais réglage des interrupteurs DIP par rapport au poids de la porte entraîne une vitesse incorrecte et donc un fonctionnement incohérent avec le service Low Energy.

 DIP "WEIGHT"					
DIP1	DIP2	DIP3	Poids d'un vantail	Vitesse d'ouverture	Performance
OFF 	OFF 	OFF 	Jusqu'à 40kg max (1 vantail) ou 2 x 27kg (2 vantaux)	0,40m/s	Performances maximales, SANS Low Energy
ON 	OFF 	OFF 	Jusqu'à 25kg	0,36m/s	Performances Low Energy
OFF 	ON 	OFF 	De 26 → 30kg	0,34m/s	NE PAS UTILISER
ON 	ON 	OFF 	De 31 → 35kg	0,31m/s	
OFF 	OFF 	ON 	De 36 → 40kg	0,29m/s	
 DIP "WEIGHT"					
DIP1	DIP2	DIP3	Poids d'un vantail	Vitesse de fermeture	Performance
Toute configuration			Jusqu'à 40kg max (1 vantail) ou 2 x 27kg (2 vantaux)	0,20m/s	Performances Low Energy

7. EXEMPLES DE RACCORDEMENT

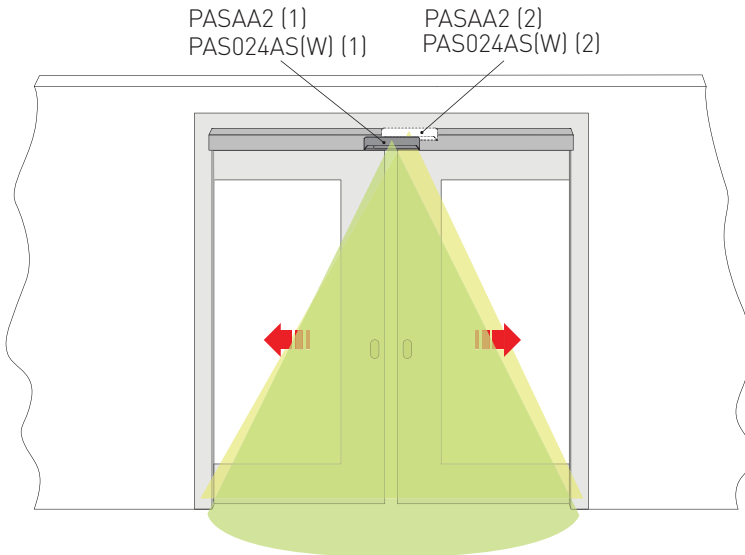

7.1 Aucun capteur de sécurité

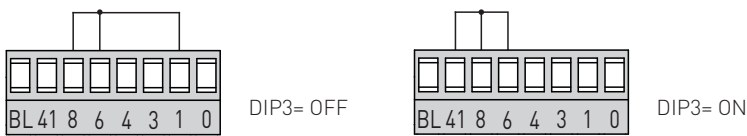

7.2 Capteurs d'ouverture et de sécurité (1 et 2)

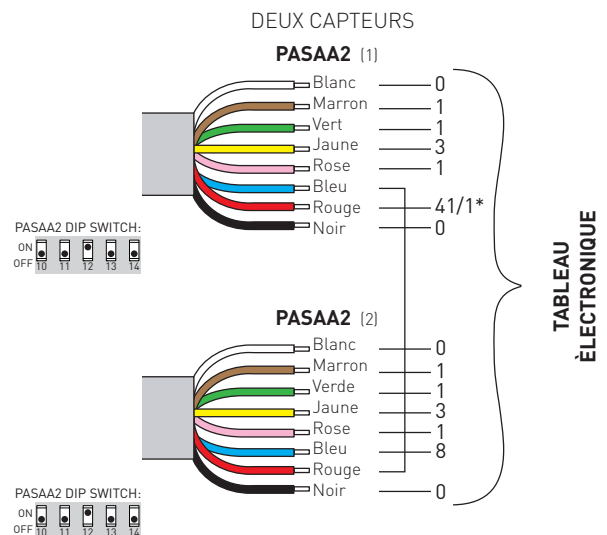
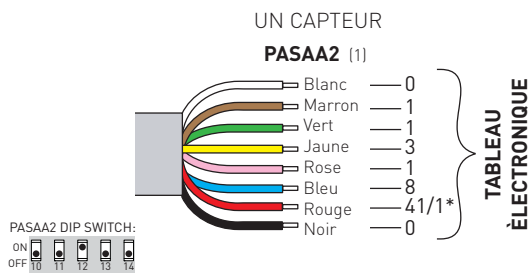

* Connecter à 41 si DIP3= ON; Connectez à 1 si DIP3= OFF

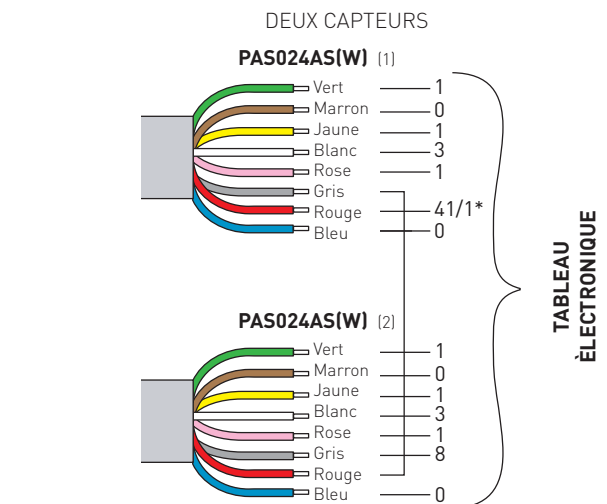
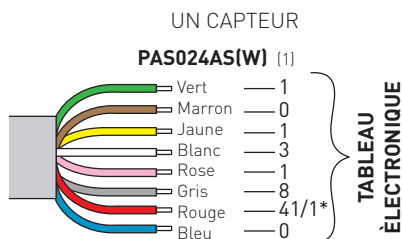

* Connecter à 41 si DIP3= ON; Connectez à 1 si DIP3= OFF

8. MISE EN MARCHÉ

- Raccorder les accessoires ;
- Shunter les contacts de sécurité 1-8 et 1-6 (41-8 et 41-6 si DIP3= ON) sur le tableau électrique s'ils ne sont pas utilisés ;
- Raccorder l'alimentation de réseau à l'automatisme ;
- Habilitier le réglage des trimmers et des interrupteurs DIP (voir le paragraphe 5.3) ;
- Sélectionner les DIP 1, 2, 3 et le trimmer TC selon le fonctionnement choisi (voir le paragraphe 5.3) ;
- Sélectionner l'interrupteur DIP Weight 1, 2, 3 selon le poids du vantail si l'on souhaite utiliser l'automatisme avec les prestations LOW ENERGY (voir le paragraphe 9).

ATTENTION : à chaque allumage, le tableau électrique exécute une restauration automatique et le premier mouvement d'ouverture ou de fermeture est exécuté à faible vitesse, permettant ainsi l'apprentissage automatique des positions de butée (acquisition).

- Contrôler le fonctionnement de la porte avec la commande d'ouverture successive.
- Vérifier le fonctionnement des accessoires raccordés.
- Si l'automatisme rencontre un obstacle lors de la course de fermeture, il le détecte et s'ouvre de nouveau. Si l'automatisme rencontre un obstacle lors de la course d'ouverture, il le détecte et s'arrête. Si l'obstacle est détecté trois fois de suite, il est considéré comme une nouvelle butée d'arrêt jusqu'à ce que l'obstacle soit retiré.
- L'automatisme est muni de la fonction Push&Go/Pull&Close. En appuyant manuellement sur la porte, aussi bien en ouverture qu'en fermeture, la manoeuvre motorisée démarre.



Si l'automatisme n'est pas alimenté, il est possible de faire glisser les portes manuellement, mais seulement en les déplaçant lentement.

9. PLAN D'ENTRETIEN ORDINAIRE

Exécuter les opérations et les vérifications suivantes tous les six mois, en fonction de l'intensité d'utilisation de l'automatisme.

Sans alimentation en 230V~ :

- Nettoyer les pièces en mouvement (les guides de coulissement des chariots).
- Contrôler la tension de la courroie.
- Nettoyer les capteurs d'ouverture et de fermeture (si présents).
- Contrôler la stabilité de l'automatisme et vérifier le serrage de toutes les vis.
- Vérifier l'alignement du vantail et la position des butées.

Fournir de nouveau l'alimentation en 230V~ :

- Contrôler la stabilité de la porte et la régularité du mouvement sans frottements.
- Contrôler le fonctionnement de toutes les fonctions de commande.
- Contrôler le fonctionnement des capteurs d'ouverture et de fermeture (si présents).
- Vérifier que l'installation est conforme aux normes en vigueur et aux exigences essentielles imposées par les autorités compétentes.



REMARQUE: pour les pièces de rechange, se reporter au catalogue des pièces de rechange.



Pour l'éventuelle réparation ou remplacement des produits seules des pièces de rechange originales devront être utilisées.

L'installateur doit fournir à l'utilisateur toutes les informations relatives au fonctionnement automatique, manuel et d'urgence de l'automatisme ou du portail motorisé, de même que le mode d'emploi.

L'installateur doit remplir le registre d'entretien, dans lequel il devra indiquer toutes les interventions d'entretien ordinaire et extraordinaire effectuées.

Allgemeine Sicherheitshinweise



Beachten Sie diese Anweisungen, die Nichteinhaltung der in dieser Gebrauchsanleitung enthaltenen Informationen kann Verletzungen von Personen oder Schäden am Gerät bewirken

Bewahren Sie diese Anweisungen für zukünftiges Nachschlagen auf.

Das vorliegende Installationshandbuch ist ausschließlich für das Fachpersonal bestimmt. Die Montage, die elektrischen Anschlüsse und Einstellungen sind unter Beachtung der Montageanweisung und Einhaltung der geltenden Normen auszuführen. Lesen Sie die Anleitungen vor der Montage des Produktes aufmerksam durch.

Eine fehlerhafte Montage kann zu Verletzungen und Sachschäden führen.



Die Verpackungsmaterialien (Kunststoff, Polystyrol usw.) müssen sachgemäß entsorgt werden und dürfen nicht in Kinderhände gelangen, da sie eine Gefahrenquelle darstellen können. Vor Beginn der Montage ist der einwandfreie Zustand des Produkts zu überprüfen.

In explosionsgefährdeten Bereichen darf das Produkt nicht eingebaut werden: Entzündbare Gase oder Rauch stellen eine ernsthafte Sicherheitsgefährdung dar.

Nehmen Sie vor der Montage des Antriebs alle Veränderungen an der Struktur für die lichten Sicherheitsräume und den Schutz bzw. die Abtrennung aller Quetsch-, Scher-, Einzieh- und allgemeiner Gefahrenstellen vor.

Es ist sicherzustellen, dass die tragende Struktur die erforderlichen Voraussetzungen an Festigkeit und Stabilität erfüllt. Der Hersteller des Antriebs schließt eine Haftungsübernahme im Falle der Nichtbeachtung der Montageanweisung bei der Fertigung der zu motorisierenden Türprofile aus. Desweiteren besteht kein Haftungsanspruch bei Verformungen, die durch den Gebrauch entstehen könnten.

Beachten Sie bei der Montage der Sicherheitseinrichtungen (Lichtschränken, Kontaktleisten, Not-Stops etc.) unbedingt die geltenden Normen und Richtlinien, die Kriterien der technischen Verhaltensregeln, die Montageumgebung, die Betriebslogik des Systems und die von der motorisierten Tür entwickelten Kräfte.

Die Sicherheitseinrichtungen dienen dem Schutz vor Quetsch-, Scher-, Einzieh- und sonstigen Gefahrenbereichen der motorisierten Tür. Zur Erkennung der Gefahrenbereiche sind die vorgeschriebenen Hinweisschilder anzubringen.

Bei jedem Einbau müssen die Kenndaten der motorisierten Tür an sichtbarer Stelle angebracht werden.

Gegebenenfalls die motorisierte Tür an eine wirksame und den Sicherheitsnormen entsprechende Erdungsanlage anschließen.



Unterbrechen Sie während der Montage-, Wartungs- oder Reparaturarbeiten die Stromzufuhr, bevor Sie den Deckel für den Zugang zu den elektrischen Geräten öffnen.

Das Schutzgehäuse des Antriebs darf ausschließlich von Fachpersonal entfernt werden.



Eingriffe an den elektronischen Geräten dürfen nur mit antistatischem geerdeten Armschutz vorgenommen werden. Der Hersteller des Antriebs lehnt jede Haftung für die Montage von sicherheits- und betriebstechnisch ungeeigneten Bauteilen ab.

Bei Reparaturen oder Austausch der Produkte dürfen ausschließlich Original-Ersatzteile verwendet werden.

Der Monteur ist verpflichtet, dem Betreiber der Anlage alle erforderlichen Informationen zum automatischen, manuellen und Notbetrieb der motorisierten Tür zu liefern und die Betriebsanleitung auszuhändigen.

Einbauerklärung für unvollständig Maschinen

Wir:

Entrematic Group AB
Lodjursgatan 10
SE-261 44 Landskrona
Sweden

erklären unter unserer Verantwortung, dass die nachstehenden Steuergerätetypen:

Ditec CIVIK, Ditec OLLY C

den folgenden Richtlinien entsprechen:

2014/30/EU	Richtlinie über die elektromagnetische Verträglichkeit (EMV)
2006/42/EG	Maschinenrichtlinie (MR) bezüglich der folgenden wesentlichen Gesundheitsund Sicherheitsanforderungen: 1.1.2, 1.2.1, 1.2.2, 1.2.3, 1.2.4.2, 1.2.6, 1.3.9, 1.4.3, 1.7.2, 1.7.4, 1.7.4.1, 1.7.4.2
2011/65/EU	zur Beschränkung der Verwendung bestimmter gefährlicher Stoffe in Elektro- und Elektronikgeräten (RoHS)

Technische Unterlagen zum sicheren Einbau sind im Lieferumfang enthalten.

Angewandte harmonisierte EU-Normen:

EN 60335 -1:2012+A11:2014	EN ISO 13849 -1:2015	EN 61000-6-1:2007	EN 61000-3-3:2013
EN 60335-2-103:2015	EN 16005:2012/AC:2015	EN 61000 -6-3:2007+A1:2011	EN 61000-3-2:2014

Der Produktionsprozess ist darauf ausgerichtet die Konformität des Geräts mit den technischen Unterlagen sicherzustellen.

Das Steuergerät darf erst in Betrieb genommen werden, wenn das eingebaute Türsystem vom Installateur als konform mit der Maschinenrichtlinie 2006/42/EG erklärt wurde.

Verantwortlich für die technische Akte ist:

Matteo Fino E-mail: matteo.fino@entrematic.com

Entrematic Group AB
Lodjursgatan 10
SE -261 44 Landskrona
Sweden

Ort
Landskrona

Datum
2020-09-02

Unterschrift
Matteo Fino

Funktion
Vorsitzender der Geschäftssparte
Entrance Automation

1. Technische daten

Spannungsversorgung	230V~ / 50-60 Hz
Stromaufnahme	0.2A
Zubehörspeisung	24V= / 0.36A
Schubkraft	30N
Öffnungsgeschwindigkeit*	0.4m/s
Schließgeschwindigkeit	0.2m/s
Einschaltdauer	S2= 20min, S3= 30%
Max. Flügelgewicht	40kg (1 anta), 55kg (2 ante)
Abmessungen	115 x 67 x 1000 [DOITOC10P], 115 x 67 x 2000 [DOITOC20P]
Max. Verfahrweg	910mm [DOITOC10P], 1860mm [DOITOC20P]
Temperatur	-20°C / +55°C
Schutzart	IP20



* Die Höchstgeschwindigkeit des Flügels hängt vom Gewicht des Flügels ab, wenn der Betrieb LOW ENERGY verwendet wird (Siehe Kap. 6).

2. HINWEISE ZUM GEBRAUCH

Verwendung: INTENSIV. Ditec Olly C wurde für die Installation an handelsüblichen Gleitschienen für Einbauschiebetüren konzipiert. Er ist die ästhetisch ideale Lösung, um Schiebetüren im Wohnbereich automatisch zu betreiben.

3. VERWEIS ABBILDUNGEN

Die Funktionsgarantie und die angegebenen Leistungen werden nur mit Zubehör und Sicherheitsvorrichtungen von DITEC erzielt.

3.1 Verweis auf Standard-Montage (Abb. 1-4)

- [1] Antrieb
- [2] Kombierter Öffnungs- und Sicherheitssensor beim Schließen
- [3] Bedieneinheit
- [4] Stromversorgung
- [10] COMGTC - Drahtloser Funktionswahlschalter (Bez. COMGC)

3.2 Verweis auf Automatisierung (Abb. 2-5)

- [5] Getriebemotor mit Schaltkreis
- [6] Umlenkung
- [7] Flügelanschlussbügel
- [8] Riemen
- [9] OCL - Funkempfänger
- [11] COMGRC - Empfänger des drahtlosen Funktionswahlschalters (Bez. COMGC)

4. MONTAGE

Sofern nichts anderes angegeben wird, gelten alle Maße in Millimeter (mm).



Allgemeine Tipps / Sicherheitsvorkehrungen

- Sorgen Sie dafür, dass ein Einklemmen zwischen beweglichen und den umgebenden feststehenden Teilen bei der Öffnungsbewegung des beweglichen Teils vermieden wird. Die folgenden Abstände gelten als ausreichend für die Vermeidung eines Einklemmens des jeweiligen Körperteils.
 - Finger: ein Abstand von über 25mm oder unter 8mm
 - Füße: ein Abstand von über 50mm
 - Kopf: ein Abstand von über 300mm
 - Gesamter Körper: ein Abstand von über 500mm
- Wenn diese Abstände nicht eingehalten werden können, ist ein Schutz erforderlich
- Gefahrenstellen müssen bis zu einer Höhe von 2,5 über dem Boden mit Schutzvorrichtungen versehen sein.
- Der Antrieb darf nicht bei einer Türanlage verwendet werden, die eine Schlupftür beinhaltet.
- Der elektrische Schalter muss in der direkten Sicht des angetriebenen Teils, jedoch von den beweglichen Teilen entfernt sein. Wenn es nicht mit einem Schlüssel betätigt wird, muss es in einer Mindesthöhe von 1,5m installiert werden und ist für die Öffentlichkeit nicht zugänglich.

4.1 Kastenbefestigung

- Wenn nötig, die Kastenlänge (an der Umlenkung) auf das Maß der lichten Öffnung der Tür kürzen

ACHTUNG: dopo il taglio riposizionare correttamente i componenti nel cassonetto. : Nach dem Zuschneiden alle Komponenten wieder korrekt im Kasten anordnen. Die Umlenkspule [6] und die Spule des Getriebemotors [5] müssen an den Endverschlüssen liegen. Den Riemen [8] angemessen spannen.

- Den Kasten laut Abb. 7 (Modell Scrigno) oder Abb. 8 (Modell Eclisse) an der oberen Führung fixieren.

4.2 Befestigung des Flügels

- Den Flügel auf Schließstellung bringen
- Den Flügelanschlussbügel [7] so weit wie möglich der Riemenscheibe nähern und diese laut Abb. 7-8 am Flügel fixieren.

ACHTUNG: Sollte die Türstärke von 40mm abweichen, entsprechende Distanzstücke verwenden (nicht im Lieferumfang).

ACHTUNG: Bei Antrieben mit zwei Flügeln müssen die Flügelanschlussbügel bündig zum Flügel positioniert werden (siehe Abb. 5).

- Die Tür von Hand öffnen und schließen und prüfen, ob der Flügel korrekt gleitet.

ACHTUNG: Den Flügel komplett öffnen und sicherstellen, dass der Flügelanschlussbügel [7] nicht gegen die Riemenscheibe schlägt.

4.3 Befestigung Anschlagssperre

Für einen korrekten Betrieb muss der Schiebeflügel zirka 90 mm vor der vollständigen Versenkung in Öffnungsposition angehalten werden. Dann den mitgelieferten Bügel für die Anschlagssperre wie auf Abb. 9 dargestellt befestigen

- Der Bügel für die Anschlagssperre kann entweder innen oder außen an der Tür befestigt werden. Die am besten geeignete Position wählen.
- Die Tür vollständig schließen und den Bügel für die Anschlagssperre über die vorhandenen Schlitze befestigen, ohne die Schrauben anzuziehen.
- Die Tür bis zum Anschlag öffnen und ~90mm sichtbar lassen.
- Die Tür wieder vollständig schließen und den Bügel für die Anschlagssperre mit einer dritten Schraube auf der Bohrung ohne Schlitz dauerhaft befestigen.

4.4 Befestigung des Funkempfängers OCL

Es kann ein Funkempfänger installiert werden, der eine Aktivierung der Tür über eine Fernbedienung ermöglicht.

- Den Funkempfänger [9] mit den mitgelieferten Schrauben im Kasten befestigen.
- Die elektrischen Anschlüsse entsprechend den Anweisungen im entsprechenden Handbuch vornehmen.
- Die Sender entsprechend den Anweisungen im entsprechenden Handbuch speichern.

4.5 Installation des Funktionswahlschalters COMGC

Es besteht die Möglichkeit der Installation des Funk-Wahlschalters, mit dem die Türfunktionen ohne Anschlusskabeln ausgewählt werden können:

- Den Empfänger [11] COMGRC mit den mitgelieferten Schrauben im Kasten fixieren.
- Die elektrischen Anschlüsse laut Anweisungen im entsprechenden Handbuch vornehmen.
- Den Sender [10] COMGTC wie im entsprechenden Handbuch angeben speichern.

5. ELEKTRISCHE ANSCHLÜSSE

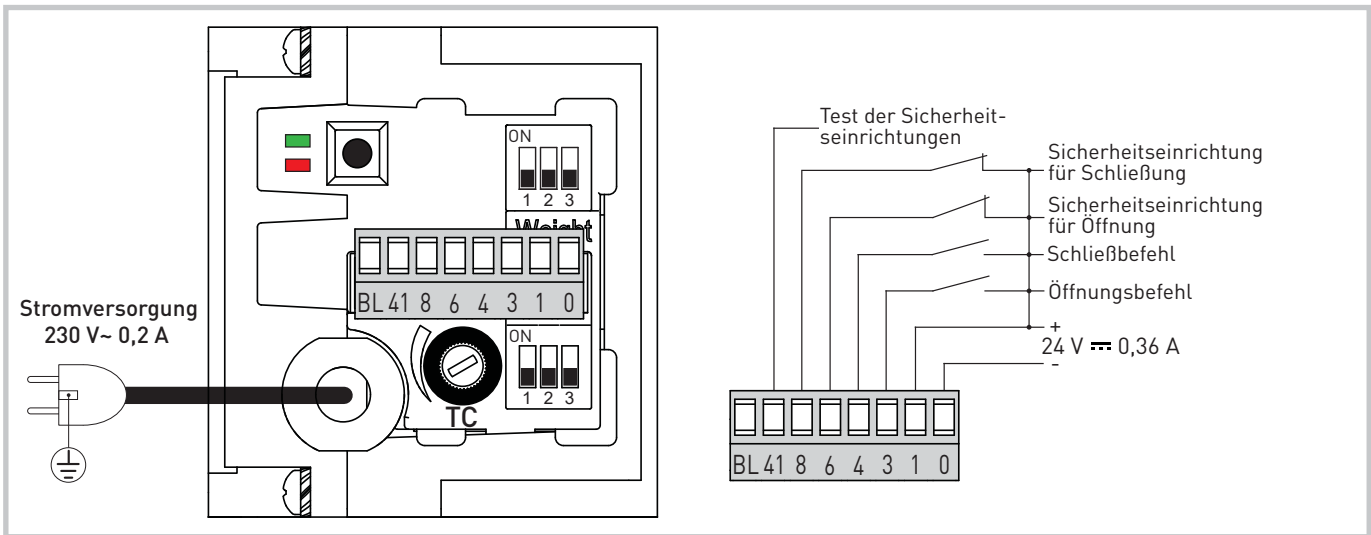

-Maximaler Drahtabschnitt, der an einer einzelnen Klemme verwendet werden kann = 1,3 mm² (26AWG)

-Wenn Sie Drähte mit einem größeren Durchmesser oder mehr Drähten verwenden, stellen Sie eine externe Verbindung mit einem speziellen Terminal (nicht mitgeliefert) her.

5.1 Befehle

Befehl	Funktion	Beschreibung
1 — 3	N.O. ÖFFNUNG	Die Betätigung des Kontakts aktiviert die Öffnung.
1 — 4	N.O. SCHLIEßUNG	Die Betätigung des Kontakts aktiviert den Schließvorgang.
1 — 3 1 — 4	N.O. STOP	Wenn gleichzeitig ein Öffnungs- und ein Schließbefehl gegeben wird, stoppt der Antrieb. ACHTUNG: Nach der Öffnung der Kontakte setzt der Antrieb die Fahrt fort.
1 — 6	N.C. NICHT VERWENDET	Kontakt 1-6 überbrücken, wenn DIP 3 =OFF, Kontakt 41-6 überbrücken, wenn DIP 3 =ON.
1 — 8	N.C. SICHERHEITSEINRICHTUNG FÜR SCHLIEßUNG	Die Öffnung des Kontaktes löst die Umkehr der Bewegung (erneute Öffnung) während der Schließphase aus. Hinw.: Wenn keine Sicherheitseinrichtung bei der Schließung verwendet wird und DIP3= ON, muss der Kontakt 41-8 überbrückt werden.
41 — (+) 0 — (-)	N.C. TEST DER SICHERHEITSEINRICHTUNGEN	Mit der Klemme 41 wird bei jedem Zyklus ein Test der Sicherheitseinrichtung aktiviert. Schlägt der Test fehl, blinkt die ROTE Led und der Test wird wiederholt. Mit DIP3=ON die Klemmen 41 und 0 des Schaltschranks an die entsprechenden Testklemmen an der Sicherheitseinrichtung anschließen. Wenn die Sicherheitseinrichtungen nicht getestet werden, siehe Beschreibung DIP3=OFF.

5.2 Ausgänge und Zubehör



Ausgang	Wert - Zubehör	Beschreibung
	24V = 0,36A	Stromversorgung des Zubehörs. Ausgang für Stromversorgung des Zubehörs.
		NICHT VERWENDEN

5.3 Einstellungen



AKTIVIERUNGSVERFAHREN FÜR DIE EINSTELLUNG DER TRIMMER/DIP-SCHALTER



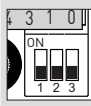

Die Trimmer und DIP-Schalter beeinflussen die Sicherheitsfunktion der Kraftbegrenzung. Ihre Einstellung muss in der angegebenen Weise durchgeführt werden (Andernfalls werden die Änderungen nicht akzeptiert, was durch das Blinken der ROTEN und GRÜNEN LED angezeigt wird):

- Während der Programmierungsphase stoppt die Automation und es können keine Befehle ausgeführt werden.
- Die Taste  4 s lang drücken (GRÜNE und ROTE LED leuchten);
- Innerhalb einer Frist von 5 Minuten die Trimmer und die DIP-Schalter einstellen;
- Zum Beenden des Vorgangs die Taste 2 Sekunden lang drücken, die Automatisierung setzt den zuvor unterbrochenen Vorgang fort.

	Beschreibung	OFF 	ON 
	DIP1 Drücken bei Schließung. Hält den Flügel in Schließstellung.	Deaktiviert.	Aktiviert
	DIP2 Wahl der Laufrichtung. Die Öffnungsrichtung muss mit von der Inspektionsseite aus betrachtetem Antrieb verstanden werden.	Öffnung nach rechts. Antrieb mit 2 Flügeln.	Öffnung nach links
	DIP3 Safety Test Klemme 41	Deaktiviert. Die Sicherheitssensoren werden nicht überwacht und die Öffnerkontakte müssen an die Klemmen 1-6 und 1-8 angeschlossen werden.	Aktiviert

TC	Zeit der automatischen Schließung.
	Von 0 bis 30 s. Regelt die Zeit, die zwischen dem Ende der Öffnungsbewegung und dem Beginn der automatischen Schließung vergeht. Bei geöffnetem Tor beginnt ein Öffnungsbefehl erneut mit der Zählung. Wenn man die automatische Schließung ausschließen möchte, muss TC auf den Höchstwert eingestellt werden.

	Beschreibung	OFF 	ON 
	Auswahl des Gewichts des Flügels für die Verwendung der Betriebsart LOW ENERGY	Siehe Kapitel 6	Siehe Kapitel 6

LED	Eingeschaltet	Blinkleuchte
Grün 	Stromversorgung vorhanden	Encoder nicht in Betrieb oder Antriebsstörung.
Rot 	Sicherheitskontakt 6 oder 8 offen.	Sicherheitstest misslungen.
Rot + Grün 	Verfahren für die Einstellung der Trimmer/Dip-Schalter aktiviert.	<ul style="list-style-type: none"> • 2 mal Blinken = Bestätigung der Einstellung der Trimmer, Dip-Schalter. • 4 mal Blinken in Abständen von 1 s zeigt an, dass eine Einstellung durchgeführt wurde, ohne dass zuvor das Einstellungsverfahren aktiviert wurde: Aktivierungsverfahren erneut durchführen.
Rot / Grün 		Abwechselndes Blinken Der Antrieb steht still, da gleichzeitig ein Öffnungs- und ein Schließbefehl empfangen wurden

















	Öffnung
	Ein kurzes Drücken aktiviert die Öffnung
	AKTIVIERUNG Einstellung Trimmer/Dip-Schalter (rote+grüne Led leuchten, siehe Aktivierungsverfahren)

6. ANFORDERUNGEN AN TÜREN FÜR DIE BENUTZUNG IM LOW ENERGY-MODUS

Der Antrieb OLLY C wird ab Werk mit der Einstellung für die maximalen Leistungen geliefert. Wenn er in der Betriebsart Low Energy verwendet wird, müssen die Dip-Schalter "Weight" je nach Gewicht des Flügels ausgewählt werden, wie in der folgenden Tabelle angegeben ist.

Hinw.: nur das Gewicht eines Flügels berücksichtigen.

Achtung: Die falsche Einstellung der Dip-Schalter für das Gewicht des Tors bewirkt eine nicht korrekte Geschwindigkeit und folglich einen nicht kohärenten Betrieb in der Betriebsart Low Energy.

					
DIP1	DIP2	DIP3	Gewicht eines Flügels	Öffnungsgeschwindigkeit	Leistung
OFF 	OFF 	OFF 	Bis max 40kg (1 Flügel) oder 2 x 27kg (2 Flügel)	0,40m/s	Maximale Leistungen, KEIN Low Energy
ON 	OFF 	OFF 	Bis 25kg	0,36m/s	Low-Energy-Leistungen
OFF 	ON 	OFF 	Von 26 → 30kg	0,34m/s	NICHT VERWENDEN
ON 	ON 	OFF 	Von 31 → 35 kg	0,31m/s	
OFF 	OFF 	ON 	Von 36 → 40kg	0,29m/s	
					
DIP1	DIP2	DIP3	Gewicht eines Flügels	Schließgeschwindigkeit	Leistung
Jede Konfiguration			Bis max 40kg (1 Flügel) oder 2 x 27kg (2 Flügel)	0,20m/s	Low-Energy-Leistungen

7. ANSCHLUSSBEISPIELE

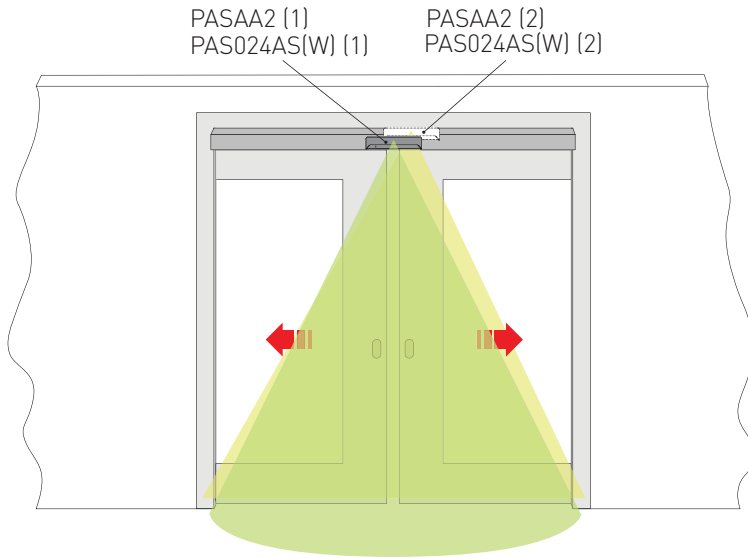

7.1 Kein Sicherheitssensor

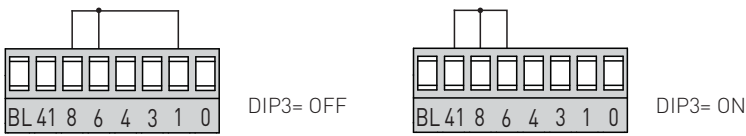

7.2 Öffnungs- und Sicherheitssensoren (1 und 2)

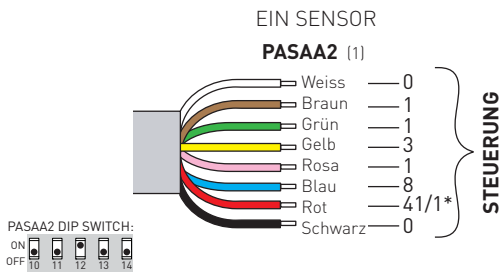

i * Verbindung zu 41 herstellen Wenn DIP3= ON; Bei 1 anschließen, wenn DIP3= OFF

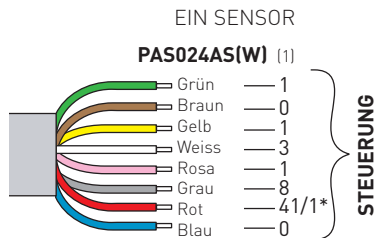
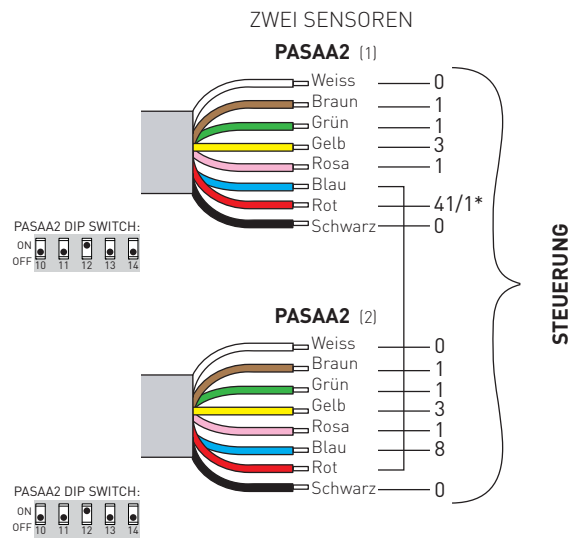

i * Verbindung zu 41 herstellen Wenn DIP3= ON; Bei 1 anschließen, wenn DIP3= OFF

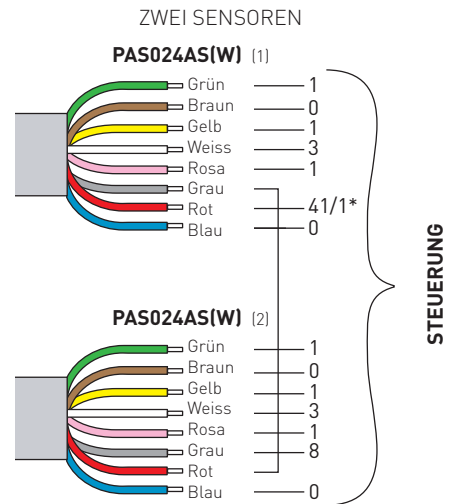

8. INBETRIEBNAHME

- Die Zubehörteile anschließen;
- Die Sicherheitskontakte 1-8 und 1-6 (41-8 und 41-6 wenn DIP3= ON) am Schaltschrank überbrücken, wenn sie nicht verwendet werden;
- Die Stromversorgung an den Antrieb anschließen;
- Die Einstellung der Trimmer/Dip-Schalter aktivieren (siehe Abschnitt 5.3);
- Die Dip-Schalter 1, 2, 3 und den Trimmer SG je nach gewünschter Betriebsweise auswählen (Siehe Abschnitt 5.3);
- Die Dip-Schalter "weight" 1, 2, 3 je nach dem Gewicht des Flügels auswählen, wenn der Antrieb mit "LOW ENERGY"-Leistungen verwendet werden soll (Siehe Abschnitt 6).

ACHTUNG: Bei jedem Einschalten führt die elektrische Schalttafel ein automatisches RESET durch und die erste Öffnungs- oder Schließbewegung erfolgt bei niedriger Geschwindigkeit und ermöglicht die automatische Aufnahme der Anschlagpositionen (Erfassung).

- Den korrekten Betrieb des Tors mit darauf folgendem Öffnungsbefehl prüfen.
- Den Betrieb des angeschlossenen Zubehörs prüfen.
- Sollte der Antrieb während des Schließlaufs auf ein Hindernis treffen, wird dieses erfasst und das Tor öffnet sich erneut. - Sollte der Antrieb während des Öffnungslaufs auf ein Hindernis treffen, wird dieses erfasst und das Tor stoppt. Wird das Hindernis dreimal hintereinander erfasst, wird es solange als neuer Anschlag betrachtet, bis es beseitigt wird.
- Der Antrieb ist mit der Funktion Push&Go/Pull&Close ausgestattet. Wird die Tür beim Öffnen oder Schließen von Hand gedrückt, schaltet sich die motorisierte Bewegung ein.



Wenn die Automation nicht mit Strom versorgt wird, ist es möglich, die Türen manuell zu schieben, aber nur langsam zu bewegen.

9. REGELMÄSSIGER WARTUNGSPLAN

Führen Sie die nachstehenden Arbeitsschritte und Überprüfungen alle 6 Monate durch, je nachdem wie oft der Antrieb verwendet wird. Ohne Stromversorgung 230V-:

- Die Bewegungsteile (die Gleitschienen der Laufwagen) reinigen.
- Die Riemenspannung prüfen.
- Die Öffnungs- und Schließsensoren reinigen (falls vorhanden).
- Die Stabilität des Automatismus kontrollieren und den festen Sitz aller Schrauben prüfen.
- Die korrekte Fluchtung des Torflügels und die Position der Anschläge prüfen.

Erneut die Stromversorgung 230V- einschalten:

- Die Stabilität der Tür und deren gleichmäßige und reibungslose Bewegung prüfen.
- Den korrekten Betrieb aller Befehlsfunktionen prüfen.
- Den korrekten Betrieb der Öffnungs- und Schließsensoren prüfen (falls vorhanden).
- Prüfen, ob die Installation den geltenden Normen und den Anforderungen der zuständigen Behörden entspricht.



ANMERKUNG: Bezüglich der Ersatzteile wird auf die i Ersatzteilliste verwiesen.



Bei Reparaturen oder Austausch der Produkte dürfen ausschließlich Original-Ersatzteile verwendet werden.

Der Monteur ist verpflichtet, dem Betreiber der Anlage alle erforderlichen Informationen zum automatischen, manuellen und Notbetrieb des Antriebs zu liefern und die Betriebsanleitung auszuhändigen.

Der Installateur muss das Wartungsheft erstellen, in welches er alle durchgeführten plan und außerplanmäßigen Wartungsarbeiten eintragen muss.

Advertencias generales para la seguridad



El incumplimiento de las instrucciones contenidas en este manual puede causar accidentes personales o daños en el equipo.
Conserve estas instrucciones para futuras consultas.

Este manual de montaje y la instalación está destinado exclusivamente al personal cualificado. La instalación, las conexiones eléctricas y las regulaciones deben ser efectuadas por personal cualificado aplicando la buena técnica y respetando la normativa vigente.

Lea detenidamente las instrucciones antes de comenzar la instalación del producto.

Una instalación incorrecta puede ser causa de peligro.

 El material del embalaje (plástico, poliestireno, etc.) no se debe tirar al medio ambiente y debe mantenerse fuera del alcance de los niños porque es una potencial fuente de peligro.

Antes de proceder con la instalación, compruebe que el producto se encuentra en perfectas condiciones.

No instale el producto en ambientes ni atmósferas explosivas: la presencia de gases o humos inflamables constituyen un grave peligro para la seguridad.

Antes de instalar el dispositivo, haga todos los cambios necesarios en la estructura, de modo que se puedan respetar las distancias de seguridad y proteger o aislar todas las zonas de aplastamiento, cizallado, traslado o de peligro en general.

Compruebe que la estructura existente cumple los requisitos de resistencia y estabilidad. El fabricante del dispositivo no se hace responsable de la falta de rigor a la hora de construir con buena técnica las puertas donde van a instalarse los dispositivos, como tampoco de las deformaciones que puedan producirse con el uso de los mismos.

Los dispositivos de seguridad (fotocélulas, costas sensibles, paradas de emergencia, etc.) deben instalarse teniendo en cuenta las leyes y directivas aplicables, la buena técnica, el lugar de instalación, la lógica de funcionamiento del sistema y las fuerzas creadas por la puerta o cancela motorizada.

Los dispositivos de seguridad deben proteger las posibles zonas de aplastamiento, cizallado, traslado y peligro en general de la puerta o la cancela motorizadas.

Utilice los dispositivos de señalización prescritos por las normas vigentes para determinar las zonas de peligro. Toda instalación debe dejar a la vista los datos de identificación de la puerta o la cancela motorizadas.

Cuando sea necesario, conecte la puerta o las cancelas motorizadas a una instalación de puesta a tierra eficaz, realizada siguiendo las normas de seguridad vigentes.

 Durante las operaciones de instalación, mantenimiento y reparación, desactive la alimentación antes de abrir la tapa de acceso a los componentes eléctricos.

La extracción del cárter de protección del automatismo debe ser realizada exclusivamente por personal cualificado.

 Los componentes eléctricos solo deben manipularse utilizando manguitos conductivos antiestáticos conectados a tierra. El fabricante del dispositivo declina toda responsabilidad derivada de la instalación de componentes incompatibles con la seguridad y el buen funcionamiento del aparato.

Utilice solo recambios originales para la reparación o la sustitución de los productos.

El instalador debe facilitar toda la información relativa al funcionamiento automático, manual y de emergencia de la puerta o cancela motorizadas, y entregar al usuario del sistema las instrucciones de uso.

Declaración de incorporación de las cuasi máquinas

Nosotros:
Entrematic Group AB
Lodjursgatan 10
SE-261 44 Landskrona
Sweden

declaramos bajo nuestra responsabilidad que los siguientes tipos de equipos:

Ditec CIVIK, Ditec OLLY C

Son conformes a las siguientes directivas:

2014/30/UE	Directiva de compatibilidad electromagnética (EMCD)
2006/42/CE	Directiva Máquinas (MD), relativamente a los siguientes requisitos esenciales de salud y seguridad: 1.1.2, 1.2.1, 1.2.2, 1.2.3, 1.2.4.2, 1.2.6, 1.3.9, 1.4.3, 1.7.2, 1.7.4, 1.7.4.1, 1.7.4.
2011/65/UE	sobre restricciones a la utilización de determinadas sustancias peligrosas en aparatos eléctricos y electrónicos (RoHS)

Documentación técnica correspondiente a la integración segura suministrada.

Normas europeas armonizadas que se han aplicado:

EN 60335 -1:2012+A11:2014	EN ISO 13849 -1:2015	EN 61000-6-1:2007	EN 61000-3-3:2013
EN 60335-2-103:2015	EN 16005:2012/AC:2015	EN 61000 -6-3:2007+A1:2011	EN 61000-3-2:2014

El proceso de producción garantiza que el equipo sea conforme a la documentación técnica.

El equipo no deberá ponerse en funcionamiento hasta que el sistema de la puerta final no haya sido instalado y declarado conforme a la Directiva Máquinas 2006/42/CE por el instalador.

Responsable del expediente técnico:

Matteo Fino E-mail: matteo.fino@entrematic.com

Entrematic Group AB
Lodjursgatan 10
SE -261 44 Landskrona
Sweden

Lugar
Landskrona

Fecha
2020-09-02

Firma
Matteo Fino

Cargo
Entrance Automation President

1. DATOS TÉCNICOS

Alimentación	230V~ / 50-60 Hz
Consumo	0.2A
Alimentación accesorios	24V= / 0.36A
Empuje	30N
Velocidad en apertura*	0.4m/s
Velocidad en cierre	0.2m/s
Intermitencia	S2= 20min, S3= 30%
Peso máx	40kg (1 hoja), 55kg (2 hojas)
Dimensiones	115 x 67 x 1000 [DOITOC10P] , 115 x 67 x 2000 [DOITOC20P]
Corsa max	910mm [DOITOC10P], 1860mm [DOITOC20P]
Temperatura	-20°C / +55°C
Grado de protección	IP20

i * La velocidad máxima de la hoja varía en función del peso de la hoja cuando se utiliza el modo LOW ENERGY (Véase el cap. 6).

2. INDICACIONES DE USO

Uso: INTENSO. Ditec Olly C está diseñada para instalarse en guías comerciales para puertas empotrables correderas. Es la solución estética para automatizar las puertas correderas residenciales

3. REFERENCIAS ILUSTRACIONES

La garantía de funcionamiento y las prestaciones declaradas se obtienen sólo con accesorios y dispositivos de seguridad DITEC.

3.1 Referencias instalación tipo (fig. 1-4)

- [1] Actuador
- [2] Sensor combinado de apertura y de seguridad en cierre
- [3] Teclado
- [4] Alimentación
- [10] COMGTC - Selector de funciones inalámbrico (ref. COMGC)

3.2 Referencias automatismos (fig. 2-5)

- [5] Motorreductor con cuadro electrónico
- [6] Transmisión
- [7] Estribo enganche hoja
- [8] Correa
- [9] OCL - Receptor radio
- [11] COMGRC - Receptor del selector de funciones inalámbrico (ref. COMGC)

4. INSTALACIÓN

Consejos generales / Riesgos de seguridad

Asegúrese de que no existe peligro de atrapamiento entre la pieza móvil y las piezas fijas circundantes durante el movimiento de apertura. Las siguientes distancias se consideran suficientes para evitar el atrapamiento de las piezas del cuerpo identificado:

- para los dedos, una distancia superior a 25mm o inferior a 8mm
- para los pies, a una distancia superior a 50mm
- para la cabeza, a una distancia superior a 300mm
- y para todo el cuerpo, una distancia superior a 500mm

Si no se pueden alcanzar estas distancias, es necesaria la protección.

- Los puntos de peligro deben protegerse hasta una altura de 2,5m del nivel del suelo.
- El mecanismo no debe utilizarse en conjuntos de puertas que incorporen puerta batiente manual en la periferia.
- El interruptor eléctrico debe colocarse en la vista directa de la parte accionada, pero lejos de las partes móviles. A menos que se opere con una llave, debe instalarse a una altura mínima de 1,5m y no ser accesible para el público.

Todas las medidas reportadas están expresadas en mm, salvo indicación contraria.

4.1 Fijación para caja

- Si fuera necesario, acorte la longitud del contenedor (lado transmisión) a la medida del espacio paso de la puerta.

ATENCIÓN: después del corte, vuelva a colocar correctamente los componentes en el contenedor. La polea de transmisión [6] y la polea del motorreductor [5] deben estar junto a las tapas. Tienda la correa [8] de forma adecuada.

- Fije el contenedor a la guía superior de la puerta como se indica en la figura fig. 7 (modelo Scrigno) o bien en la fig. 8 (modelo Eclipse).

4.2 Fijación de la hoja

- Lleve la hoja a la posición de cierre.
- Acerque lo más posible el estribo de enganche hoja [7] a la polea y fíjela a la hoja como se indica en la fig. 7-8.

ATENCIÓN: si el espesor de la puerta es diferente de 40mm, use espesores adecuados que nosotros no suministramos.

ATENCIÓN: en caso de automatismo de dos hojas, los estribos de enganche hoja deben colocarse a ras de hoja como indica la fig. 5.

- Abra y cierre manualmente la puerta comprobando el correcto deslizamiento de la hoja.

ATENCIÓN: abra completamente la hoja y compruebe que el estribo de enganche hoja [7] no golpee contra la polea.

4.3 Fijación tope de sujeción

Para un correcto funcionamiento es necesario fijar la hoja cor-rediza unos 90mm antes de su encaje completo en posición de apertura. Por tanto, fije el estribo tope de sujeción suministrado como se indica en la fig.9.

- El estribo tope de sujeción puede fijarse indiferentemente tanto en el lado interno como en el lado externo de la puerta. Escoja la posición más adecuada.
- Cierre completamente la puerta y fije el estribo tope de sujeción mediante las ranuras sin apretar los tornillos.
- Abra la puerta hasta el tope y dejando unos ~90 mm de vano.
- Vuelva a cerrar completamente la puerta, apriete los tornillos y fije permanentemente el estribo tope de sujeción mediante un tercer tornillo en el orificio no ranurado.

4.4 Fijación del receptor radio OCL

Es posible instalar un receptor radio que permite la activación de la puerta mediante mandos sin cables de conexión.

- Fije el receptor radio [9] dentro del contenedor hoja mediante los tornillos suministrados.
- Efectúe las conexiones eléctricas como se indica en el correspondiente manual.
- Memorice los transmisores como se indica en el correspondiente manual.

4.5 Instalación del selector de funciones COMGC

Es posible instalar el selector de radio que permite la selección de las funciones de la puerta sin cables de conexión:

- Fije el receptor [11] COMGRC en el interior de la caja mediante los tornillos suministrados.
- Efectúe las conexiones eléctricas como se indica en el correspondiente manual.
- Memorice el transmisor [10] COMGTC como se indica en el manual correspondiente.

5. CONEXIONES ELÉCTRICAS

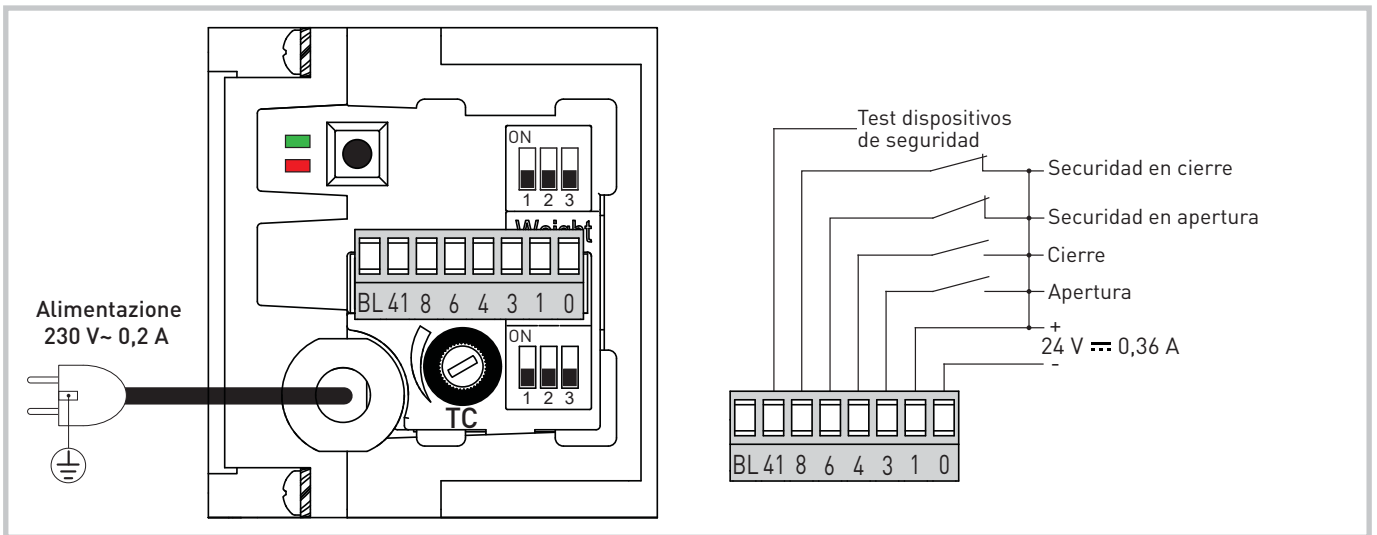

-Sección máxima del cable que se puede usar en una sola abrazadera = 1.3 mm² (26 AWG).

-Si se utilizan cables con un diámetro mayor o más, haga una conexión externa utilizando un terminal especial (no suministrado).

5.1 Mandos

Comando	Función	Descripción
1 — 3 N.O.	APERTURA	El cierre del contacto activa la maniobra de apertura.
1 — 4 N.O.	CIERRE	El cierre del contacto activa la maniobra de cierre.
1 — 3 N.O. 1 — 4 N.O.	STOP	Si se producen un mando abre y un mando cierra simultáneamente, se detendrá todo movimiento. ATENCIÓN: al volver a abrirse el contacto, la puerta retoma la maniobra que había quedado interrumpida.
1 — 6 N.C.	NO UTILIZADO	Conectar con puente el contacto 1-6 si el interruptor DIP 3 =OFF Conectar con puente el contacto 41-6 si el interruptor DIP 3 =ON
1 — 8 N.C.	SEGURIDAD EN CIERRE	La apertura del contacto causa la inversión del sentido de movimiento (reapertura) durante la fase de cierre. Nota: Si no se utiliza ningún dispositivo de seguridad en cierre y el DIP3= ON, se debe conectar con puente el contacto 41-8.
41 — (+) 0 — (-)	TEST DISPOSITIVOS DE SEGURIDAD	Con el borne 41 se activa en cada ciclo un test de seguridad del dispositivo. Si se produce un error en el test, el led ROJO parpadea brevemente y se repite el test. Con DIP3=ON conecte los bornes 41 y 0 del cuadro electrónico a los correspondientes bornes de prueba que se encuentran en el dispositivo de seguridad. Si los dispositivos de seguridad no se han probado, véase la descripción DIP3=OFF.

5.2 Salidas y accesorios



Salida	Valor - Accesorios	Descripción
	24V ~ 0,36A	Alimentación accesorios. Salida para alimentación accesorios externos.
		NO SE DEBE USAR

5.3 Regulaciones



PROCEDIMIENTO DE HABILITACIÓN PARA REGULACIÓN DEL TRIMMER/INTERRUPTORES DIP





Los trimmers y los interruptores dip afectan a la función de seguridad de limitación de las fuerzas. Deben regularse siguiendo las instrucciones puesto que, de lo contrario, las modificaciones no serán aceptadas y los LED ROJO y VERDE no parpadearán para indicarlo):

- Durante la fase de programación, la automatización se detiene y no es posible ejecutar comandos.
- Pulse el botón  durante 4 s (LED VERDE y ROJO encendidos);
- Regule los trimmers y los interruptores Dip en un tiempo máximo de 5 minutos;
- Pare terminar el procedimiento, pulse el botón durante 2 s., la automatización continúa la operación previamente interrumpida.

		Descripción	OFF 	ON 
	DIP1	Empuje en cierre. Mantiene a la hoja en posición de cierre.	Desactivada	Habilitada
	DIP2	Selección sentido de marcha. El sentido de apertura corresponde al del automatismo visto desde el lado inspeccionable.	Apertura derecha. Automatismo de 2 hojas.	Apertura izquierda
	DIP3	Safety test borne 41	Deshabilitado. Los sensores de seguridad no se monitorizan y los contactos N.C. deben conectarse a los bornes 1-6 y 1-8.	Habilitada

TC	Tiempo de cierre automático. De 0 a 30 s.
	Determina el tiempo que transcurre entre el final de la maniobra de apertura y el inicio del cierre automático. La cuenta atrás vuelve a empezar si se recibe una orden de apertura con la puerta abierta. Si se desea desactivar el cierre automático, ajuste el TC en el valor máximo.

	Descripción	OFF 	ON 
	DIP "WEIGHT" Selección del peso de la hoja para el uso LOW ENERGY	Véase el capítulo 6	Véase el capítulo 6

LED	Encendido	Intermitente
Verde 	Presencia de alimentación	El codificador no funciona o hay una anomalía en el automatismo.
Rojo 	Contacto de seguridad 6 o 8 abiertos	Error del test de seguridad.
Rosso + Verde 	Procedimiento habilitado de regulación del trimmer/interruptores Dip.	<ul style="list-style-type: none"> • 2 destellos = confirma la regulación del trimmer, interruptores Dip. • 4 destellos a intervalos de 1 s, indica que se ha realizado la regulación sin haber habilitado antes el procedimiento de regulación: vuelva a realizar el procedimiento de habilitación.
Rojo / Verde 		Intermitente alternadamente el automatismo se detiene cuando se emite una orden de apertura y una orden de cierre al mismo tiempo.

















	Apertura: Con una presión breve se activa la maniobra de apertura
	HABILITACIÓN regulación trimmer/interruptores Dip (led rojo+verde encendidos, véase procedimiento de habilitación)

6. REQUISITOS DE LAS PUERTAS PARA UTILIZARLAS EN EL MODO LOW ENERGY

El automatismo OLLY C se suministra configurado de fábrica con las máximas prestaciones. Si se utiliza en el modo Low Energy es necesario seleccionar los interruptores dip "Weight" en función del peso de la hoja, como se indica en la tabla siguiente.

Nota: hay que tener en cuenta el peso de una sola hoja.

¡Atención! : un ajuste incorrecto de los interruptores DIP con respecto al peso de la puerta comporta una velocidad incorrecta y, por consiguiente, un funcionamiento no coherente con el uso en modo Low Energy.

					
DIP1	DIP2	DIP3	Peso de una hoja	Velocidad Apertura	Prestación
OFF 	OFF 	OFF 	Hasta 40kg máx. (1 hoja) o 2 x 27kg (2 hojas)	0,40m/s	Máximas prestaciones, NO Low Energy
ON 	OFF 	OFF 	Hasta 25kg	0,36m/s	Prestaciones Low Energy
OFF 	ON 	OFF 	De 26 → 30kg	0,34m/s	NO UTILIZAR
ON 	ON 	OFF 	De 31 → 35kg	0,31m/s	
OFF 	OFF 	ON 	De 36 → 40kg	0,29m/s	

					
DIP1	DIP2	DIP3	Peso de una hoja	Velocidad de cierre	Prestación
Cualquier configuración			Hasta 40kg máx. (1 hoja) o 2 x 27kg (2 hojas)	0,20m/s	Prestaciones Low Energy

7. EJEMPLOS DE CONEXIÓN

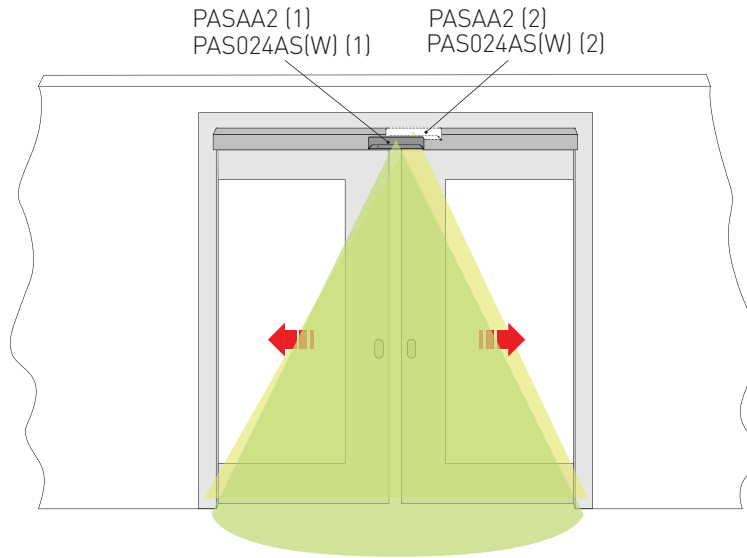

7.1 Ningún sensor de seguridad

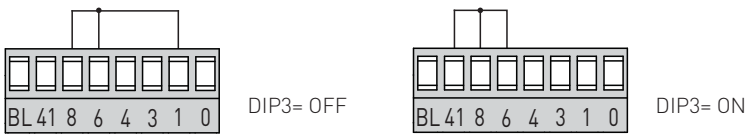

7.2 Sensores de apertura y seguridad (1 y 2)

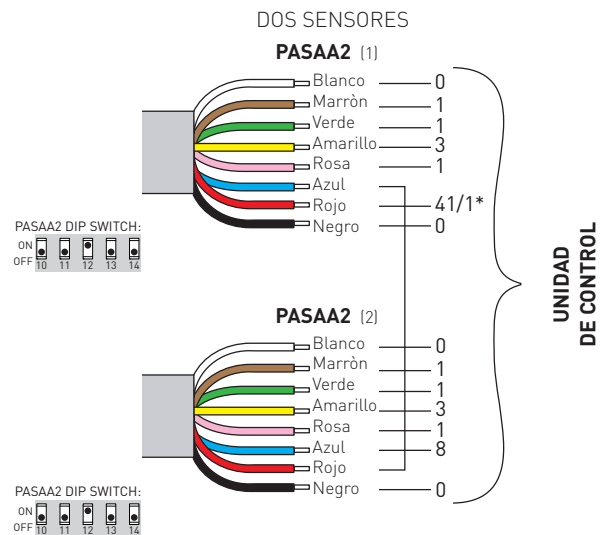
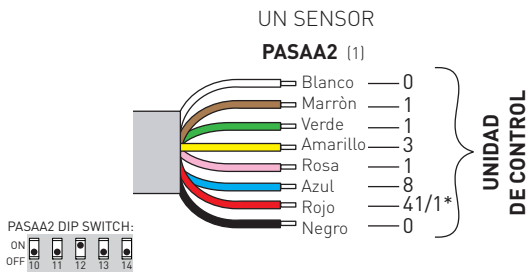

i * Conectar a 41 si DIP3= ON; conectar a 1 si DIP3= OFF

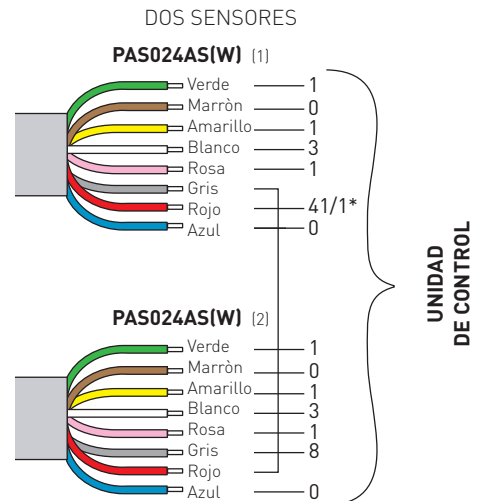
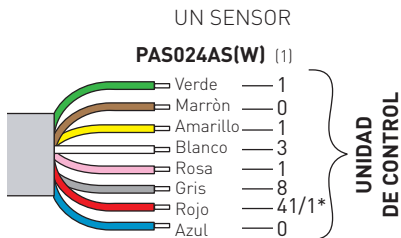

i * Conectar a 41 si DIP3= ON; conectar a 1 si DIP3= OFF

8. PUESTA EN MARCHA

- Conecte los accesorios;
- Conecte con un puente los contactos de seguridad 1-8 y 1-6 (41-8 y 41-6 si DIP3= ON) del cuadro eléctrico si no se utilizan;
- Conecte la alimentación de red al automatismo.
- Habilite la regulación de los trimmers/interruptores dip (véase el apartado 5.3);
- Seleccione los interruptores dip 1, 2, 3 y el trimmer TC en base al funcionamiento que se desee (véase el apartado 5.3);
- Seleccione dip "weight" 1, 2, 3 dependiendo del peso de la hoja, si se desea utilizar el automatismo en modo LOW ENERGY (Véase apartado 6).

ATENCIÓN: en cada encendido el cuadro eléctrico realiza un RESET automático. El primer movimiento de apertura o cierre se realiza lentamente para que el sistema pueda memorizar automáticamente las posiciones de tope (adquisición).

- Ejecute un mando de apertura para comprobar que la puerta funciona correctamente.
- Compruebe el funcionamiento de los accesorios conectados.
- Si el automatismo topa con un obstáculo durante la carrera de cierre, lo detecta y vuelve a abrirse.
- Si topa con un obstáculo durante la carrera de apertura, lo detecta y se detiene. Si detecta un mismo obstáculo tres veces consecutivas, el sistema lo considera un nuevo tope de parada hasta que desaparezca.
- El automatismo está dotado de la función Push&Go/Pull&Close. Empujando manualmente la puerta, tanto en apertura como en cierre, se pone en marcha la maniobra motorizada.



Si la automatización no está energizada, es posible deslizar las puertas manualmente, pero solo moviéndolas lentamente.

9. PLAN DE MANTENIMIENTO ORDINARIO

Efectúe las siguientes operaciones y comprobaciones cada 6 meses, en función de la intensidad de uso del automatismo.

Sin alimentación 230V~:

- Limpie los componentes en movimiento (las guías de deslizamiento de los carros).
- Compruebe la tensión de la correa.
- Limpie los sensores de apertura y cierre (si están presentes).
- Compruebe la estabilidad del automatismo y que todos los tornillos estén bien apretados.
- Compruebe la alineación correcta de la hoja y la posición de los topes.

Reactive la alimentación 230V~:

- Compruebe la estabilidad de la puerta y que ésta se mueve regularmente y sin roces.
- Compruebe el funcionamiento correcto de todas las funciones de mando.
- Compruebe el funcionamiento correcto de los sensores de apertura y cierre (si están presentes).
- Compruebe que la instalación sea conforme a las normas vigentes y a los requisitos esenciales impuestos por las autoridades competentes.



NOTA: consulte las partes de repuesto en la lista de recambios.



Utilice solo recambios originales para la reparación o la sustitución de los productos.

El instalador debe facilitar toda la información relativa al funcionamiento automático, manual y de emergencia del automatismo o cancela motorizados, y entregar al usuario del sistema las instrucciones de uso.

El instalador debe cumplimentar el registro de mantenimiento, donde deberá indicar todas las intervenciones de mantenimiento ordinario y extraordinario que se hayan realizado.

Advertências gerais para a segurança



A não observância das informações contidas neste manual pode resultar em lesões pessoais ou danos ao dispositivo. Conserve as presentes instruções para consultas futuras

Este manual de montagem e instalação é dirigido unicamente a pessoal qualificado.

A instalação, as ligações elétricas e as regulações devem ser efetuadas por pessoal qualificado na observância da Boa Técnica e em respeito das normas vigentes.

Ler atentamente as instruções antes de iniciar a instalação do produto.

Uma instalação errada pode ser fonte de perigo.



Os materiais da embalagem (plástico, poliestireno, etc.) não devem ser abandonados no ambiente e não devem ser deixados ao alcance de crianças porque são fontes potenciais de perigo.

Antes de iniciar a instalação, verificar a integridade do produto.

Não instalar o produto em ambiente e atmosfera explosivos: presença de gases ou fumos inflamáveis constituem um grave perigo para a segurança.

Antes de instalar a motorização, efetue todas as modificações estruturais relativas à realização dos dispositivos de segurança e a proteção ou isolamento de todas as áreas de esmagamento, corte, transporte e de perigo em geral.

Verifique se a estrutura existente tem os necessários requisitos de robustez e estabilidade. O fabricante da motorização não é responsável da não observância da Boa Técnica na fabricação dos infixos a motorizar, e também das deformações que devessem intervir no uso.

Os dispositivos de segurança (fotocélulas, suportes de borracha sensíveis, paragens de emergência, etc.) devem ser instalados levando em conta as leis e diretivas em vigor, os critérios da Boa Técnica, o ambiente de instalação, a lógica de funcionamento do sistema e as forças desenvolvidas pela porta ou o portão motorizado.

Os dispositivos de segurança devem proteger as eventuais áreas de esmagamento, corte, transporte e de perigo em geral, da porta ou portão motorizados.

Aplique as sinalizações previstas pelas normas vigentes para localizar as zonas perigosas.

Cada instalação deve haver visível a indicação dos dados identificativos da porta ou portão motorizados.

Quando pedido, ligue a porta ou portões motorizados a um eficaz sistema de ligação à terra realizado como indicado pelas vigentes normas de segurança.



Durante as intervenções de instalação, manutenção e reparação, desligar a alimentação antes de abrir a tampa para ter acesso às partes elétricas.

A remoção do cárter de proteção do automatismo deve ser realizada exclusivamente por pessoal qualificado.



A manipulação das partes eletrónicas deve ser efetuada equipando-se de abraçadeiras condutivas antiestáticas ligadas a terra. O fabricante da motorização declina qualquer responsabilidade sempre que sejam instalados componentes incompatíveis aos fins da segurança e do bom funcionamento.

Para a eventual reparação ou a substituição dos produtos deverão ser utilizadas exclusivamente peças de reposição originais.

O instalador deve fornecer todas as informações relativas ao funcionamento automático, manual e de emergência da porta ou portão motorizados, e entregar ao utilizador do sistema nas instruções de uso.

Declaração de Incorporação das quase-máquinas

Nós:
Entrematic Group AB
Lodjursgatan 10
SE-261 44 Landskrona
Sweden

declaramos sob nossa responsabilidade que os seguintes tipos de equipamento:

Ditec CIVIK, Ditec OLLY C

Estão em conformidade com as seguintes diretivas:

2014/30/UE	Diretiva de Compatibilidade Eletromagnética (EMCD)
2006/42/CE	Diretiva das Máquinas (MD), relativamente aos seguintes requisitos essenciais de saúde e segurança: 1.1.2, 1.2.1, 1.2.2, 1.2.3, 1.2.4.2, 1.2.6, 1.3.9, 1.4.3, 1.7.2, 1.7.4, 1.7.4.1, 1.7.4.2
2011/65/UE	relativa à restrição do uso de determinadas substâncias perigosas em equipamentos eléctricos e electrónicos (RoHS)

Documentação técnica fornecida relativa à integração segura.

Foram aplicados os seguintes padrões europeus harmonizados:

EN 60335 -1:2012+A11:2014	EN ISO 13849 -1:2015	EN 61000-6-1:2007	EN 61000-3-3:2013
EN 60335-2-103:2015	EN 16005:2012/AC:2015	EN 61000 -6-3:2007+A1:2011	EN 61000-3-2:2014

O processo de produção é destinado a garantir a conformidade do equipamento à documentação técnica.

O equipamento não deve ser colocado em serviço até que o sistema final da porta instalado não tenha sido declarado em conformidade com a Diretiva das Máquinas 2006/42/CE do instalador.

Responsável do fascículo técnico:

Matteo Fino E-mail: matteo.fino@entrematic.com

Entrematic Group AB
Lodjursgatan 10
SE -261 44 Landskrona
Sweden

Local
Landskrona

Data
2020-09-02

Assinatura
Matteo Fino

Cargo
Presidente Entrance Automation

1. DADOS TÉCNICOS

Alimentação	230V~ / 50-60 Hz
Absorção	0.2A
Alimentação acessórios	24V= / 0.36A
Tomada	30N
Velocidade de abertura*	0.4m/s
Velocidade de fecho	0.2m/s
Intermitência	S2= 20min, S3= 30%
Alcance máxima	40kg (1 folha), 55kg (2 folhas)
Dimensões	115 x 67 x 1000 [DOITOC10P] , 115 x 67 x 2000 [DOITOC20P]
Curso máx	910mm [DOITOC10P], 1860mm [DOITOC20P]
Temperatura	-20°C / +55°C
Grau de protecção	IP20



*A velocidade máxima da portinhola varia de acordo com o peso da portinhola se for utilizado o serviço LOW ENERGY (ver o cap. 6).

2. INDICAÇÕES DE UTILIZAÇÃO

Uso: INTENSO. Ditec Olly C foi projetada para ser instalada sobre guias comerciais para portas embutidas. É a solução estética para tornar automáticas as portas de correr residenciais.

3. REFERÊNCIAS ILUSTRAÇÕES

A garantia de funcionamento e as performances declaradas se obtêm somente com acessórios e dispositivos de segurança DITEC.

3.1 Referências de instalação tipo (fig. 1-4)

- [1] Accionador
- [2] Sensor combinado para abertura e de segurança em fecho
- [3] Botoeira
- [4] Alimentação
- [10] COMGTC - Seletor de funções wireless (ref. COMGC)

3.2 Referências da automação (fig. 2-5)

- [5] Moto-redutor com quadro electrónico
- [6] Intermédio
- [7] Estribo engate portinhola
- [8] Correia
- [9] OCL - Receptor rádio controlo
- [11] COMGRC - Recetor do seletor de funções wireless (rif. COMGC)

4. INSTALAÇÃO

Todas as medidas indicadas são expressas em milímetros (mm), excepto diversa indicação.



Sugestões gerais / Preocupações de segurança

- Certifique-se de que seja evitada a força de contacto entre a peça de transmissão e as peças fixas circundantes devido ao movimento de abertura da peça de transmissão. As seguintes distâncias são consideradas suficientes para evitar forças de contacto para as peças do corpo identificado:
 - para dedos, uma distância superior a 25mm ou inferior a 8 mm
 - para pés, uma distância superior a 50mm
 - para cabeças, uma distância superior a 300mm
 - e para todo o corpo, a uma distância superior a 500mm
- Se essas distâncias não puderem ser alcançadas, a protecção é necessária.
- Os pontos de perigo devem ser salvaguardados a uma altura de 2,5m a partir do nível do pavimento.
- O mecanismo não deve ser utilizado com uma porta que incorpore uma porta com postigo.
- O interruptor eléctrico deve ser posicionado na visão direta da parte accionada, mas longe das partes móveis. A menos que operado por uma chave, ele deve ser instalado a uma altura mínima de 1,5m e não acessível ao público.

4.1 Fixação contentor

- Se necessário, encurtar o comprimento do contentor (lado intermédio) conforme à medida do vão de passagem da porta.

ATENÇÃO: após o corte, reposicionar correctamente os componentes no contentor. A polia intermédia [6] e a polia do motoredutor [5] devem encontrar-se atrás dos cabeçotes. Esticar a correia [8] de forma adequada.

- Fixar o contentor à guia superior da porta, conforme indicado na fig. 7 (modelo Scigno) ou na fig. 8 (modelo Eclipse).

4.2 Fixação portinhola

- Trazer a portinhola em posição de fechamento.
- Aproximar o mais possível o estribo engate portinhola [7] à polia e fixá-la à portinhola conforme indicado na fig. 7-8.

ATENÇÃO: caso a espessura da porta seja diferente do valor de 40mm, usar adequadas espessuras - não fornecidas por nós.

ATENÇÃO: em caso de automação a duas portinholas, os estribos engate portinhola devem ser posicionadas a fio portinhola conforme indicado na fig. 5.

- Abrir e fechar à mão a porta, verificando o correcto deslizamento da portinhola.

ATENÇÃO: abrir completamente a portinhola e verificar que o estribo engate portinhola [7] não bata contra a polia.

4.3 Fixação bloqueador de batida

Para um funcionamento correcto é necessário parar a portinhola deslizante aproximadamente 90mm antes que fique completamente encaixada em posição de abertura. Fixar portanto o bloqueador de batida em dotação, conforme indicado na fig. 9.

- O bloqueador de batida pode ser fixado indiferentemente tanto no lado interno como no lado externo da porta. Escolher a posição mais apropriada.
- Fechar completamente a porta e fixar o bloqueador de batida mediante as ranhuras presentes sem apertar os parafusos.
- Abrir a porta até a batida, deixando -90mm na janela.
- Fechar completamente a porta, apertar os parafusos e fixar permanentemente o bloqueador de batida através de um terceiro parafuso num orifício não ranhurado.

4.4 Fixação receptor rádio controlo OCL

É possível instalar o receptor rádio, que permite a activação da porta mediante comandos sem cabos de ligação.

- Fixar o receptor rádio [9] no interior do caixote mediante os parafusos em dotação.
- Efectuar as ligações eléctricas, conforme indicado no manual.
- Memorizar os transmissores, conforme indicado no manual.

4.5 Instalação do seletor de funções COMGC

É possível instalar o seletor de rádio que aceita a selecção das funções da porta sem cabos de ligação:

- Fixar o receptor [11] COMGRC no interior do caixote através dos parafusos em dotação.
- Efectuar as ligações eléctricas, conforme indicado no manual.
- Memorizar o transmissor [10] COMGTC, conforme indicado no manual.

5. LIGAÇÕES ELÉCTRICAS

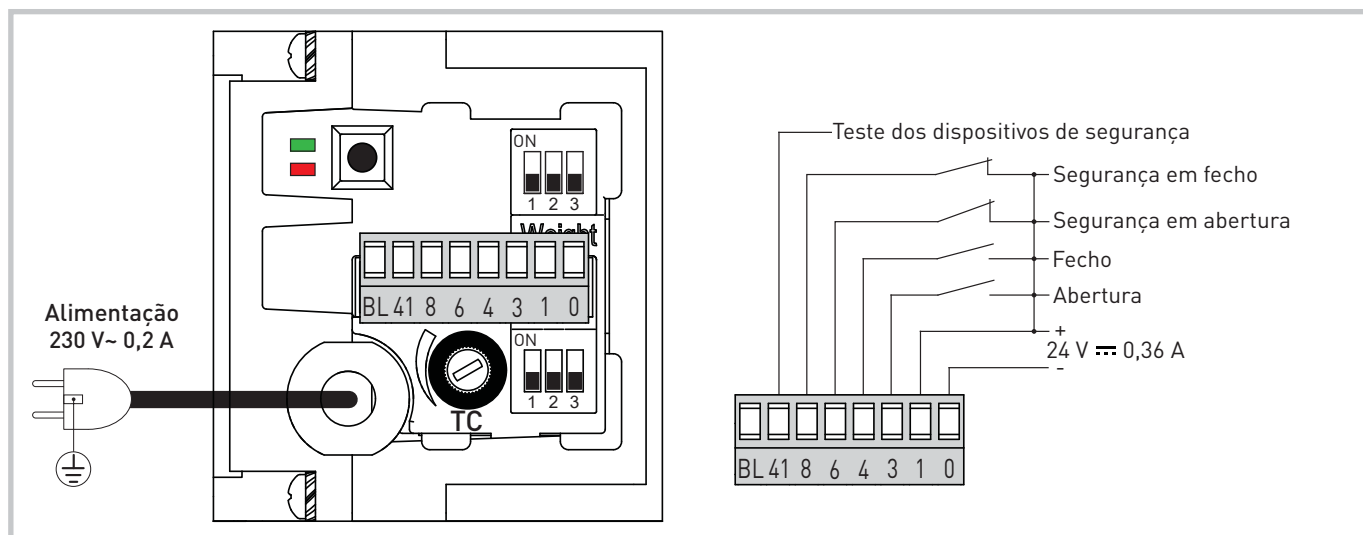

- i** -Seção de fio Max utilizável em braçadeira única = 1.3 mm² (26AWG).
 -Se forem usados fios com um diâmetro maior ou mais fios, faça uma conexão externa usando o terminal apropriado (não fornecido).

5.1 Comandos

Comando	Função	Descrição
1 — 3	N.O. ABERTURA	O fecho do contacto activa a manobra de abertura.
1 — 4	N.O. FECHO	O fecho do contacto activa a manobra de fecho.
1 — 3 1 — 4	N.O. STOP	A coexistência de um comando abre e de um comando fecha efectua a paragem de qualquer movimento. ATENÇÃO: quando o contacto se abre novamente, a porta retoma a manobra parada.
1 — 6	N.C. NÃO USADO	ligar com ponte o contacto 1-6 se o DIP 3 =OFF, ligar com ponte o contacto 41-6 se o DIP 3 =ON
1 — 8	N.C. SEGURANÇA EM FECHO	A abertura do contato provoca a inversão do movimento (reabertura) durante a fase de fecho. Obs.: Se não for usado nenhum dispositivo de segurança em fecho e DIP3= ON, é preciso ligar com ponte o contacto 41-8.
41 — (+) 0 — (-)	N.C. TESTE DOS DISPOSITIVOS DE SEGURANÇA	Mediante o pulsador 41 é ativado um teste do dispositivo de segurança a cada ciclo. Se o resultado do teste for negativo, o led VERMELHO pisca brevemente e o teste é repetido. Com DIP3=ON ligar os pulsadores 41 e 0 do quadro electrónico aos correspondentes pulsadores de teste presentes no dispositivo de segurança. Se os dispositivos de segurança não são testados consulte a descrição DIP3=OFF.

5.2 Saídas e acessórios



Saída	Valor - Acessórios	Descrição
	24V ~ 0,36A	Alimentação acessórios. Saída para alimentação acessórios exteriores.
		NÃO USAR

5.3 Regulações



PROCEDIMENTO DE HABILITAÇÃO DA REGULAÇÃO TRIMMERS/DIP SWITCHES



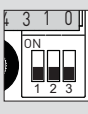

Os e trimmers e os dip switches influenciam a função de segurança de limitação das forças. A sua regulação deve ser realizada do modo indicado (caso contrário, as modificações não serão aceites e será sinalizado com o piscar dos LEDs VERMELHO e VERDE):

- Durante a fase de programação, a automação para e não é possível executar comandos.
- Pressione o botão  durante 4 s (os LEDs VERDE e VERMELHO acendem);
- Realizar a regulação dos trimmers e dos Dip switches dentro de um tempo limite de 5 min;
- Para finalizar o procedimento, pressione o botão por 2 s., a automação continua a operação interrompida anteriormente.

	Descrição	OFF 	ON 
	DIP1 Empurrão em fechamento. Mantém a portinhola em posição de fechamento.	Desabilitada.	Habilitada.
	DIP2 Seleção sentido de marcha. O sentido de abertura deve ser considerado olhando o automatismo pelo lado inspeccionável.	Abertura à direita. Automatismo com 2 portinholas.	Abertura à esquerda.
	DIP3 Safety test do prensador 41	Desativado. Os sensores de segurança não são monitorados e os contactos N.F. devem ser conectados aos prensadores 1-6 e 1-8.	Abilitata.

TC	Tempo de fechamento automático. De 0 a 30 s. Regula o tempo que há entre o fim da manobra de abertura e o início do fecho automático. Com porta aberta um comando abre renova a contagem. Se desejar excluir o fechamento automático, regular o fechamento automático, regular TC ao máximo.
-----------	--

	Descrição	OFF 	ON 
 DIP "WEIGHT"	Seleção do peso da portinhola para utilização LOW ENERGY	Consulte o capítulo 6	Consulte o capítulo 6

LED	Aceso	Lampejante
Verde 	Presença de alimentação	Encoder sem funcionamento ou anomalia no automatismo.
Vermelho 	Contacto de segurança 6 ou 8 abertos.	Teste de segurança malsucedido.
Vermelho+Verde 	Habilitado o procedimento de regulação dos trimmers/Dip switches.	<ul style="list-style-type: none"> • 2 lampejos = confirma a regulação dos trimmers e Dip switches. • 4 lampejos com intervalos de 1 s, indica que foi feita uma regulação antes de ter habilitado o procedimento de regulação: executar novamente o procedimento de habilitação.
Vermelho/Verde 		Lampeggiante alternadamente l'4 lampejos com intervalos de 1 s, indica que foi feita uma regulação antes de ter habilitado o procedimento de regulação: executar novamente o procedimento de habilitação.

	Abertura: Uma breve pressão ativa a manobra de abertura.
	HABILITAÇÃO da regulação dos trimmers/Dip-switches (led vermelho +verde acesos, consulte o procedimento de habilitação)

















6. REQUISITOS DAS PORTAS PARA UTILIZAÇÃO EM LOW ENERGY

O automatismo OLLY C é fornecido com uma configuração para permitir o máximo desempenho.

Se for utilizado com o serviço Low Energy, é necessário seleccionar os dip switches "Weight" correspondentes ao peso da portinhola, como indicado no seguinte quadro.

Obs.: considere o peso de uma portinhola única.

Atenção, uma configuração errada dos dip em relação ao peso da porta implica em uma velocidade incorreta e um funcionamento incoerente com o uso Low Energy.

 DIP "WEIGHT"					
DIP1	DIP2	DIP3	Peso de uma portinhola	Velocidade de Abertura	Desempenho
OFF 	OFF 	OFF 	Até no máx. 40kg (1 portinhola) ou 2 x 27kg (2 portinholas)	0,40m/s	Desempenho máximo, NO Low Energy
ON 	OFF 	OFF 	Até no 25kg	0,36m/s	Desempenho Low Energy
OFF 	ON 	OFF 	De 26 → 30kg	0,34m/s	NÃO USAR
ON 	ON 	OFF 	De 31 → 35kg	0,31m/s	
OFF 	OFF 	ON 	De 36 → 40kg	0,29m/s	
 DIP "WEIGHT"					
DIP1	DIP2	DIP3	Peso de uma portinhola	Velocidade de Fecho	Desempenho
Qualquer configuração			Até no máx. 40kg (1 portinhola) ou 2 x 27kg (2 portinholas)	0,20m/s	Desempenho Low Energy

7. EXEMPLOS DE LIGAÇÃO

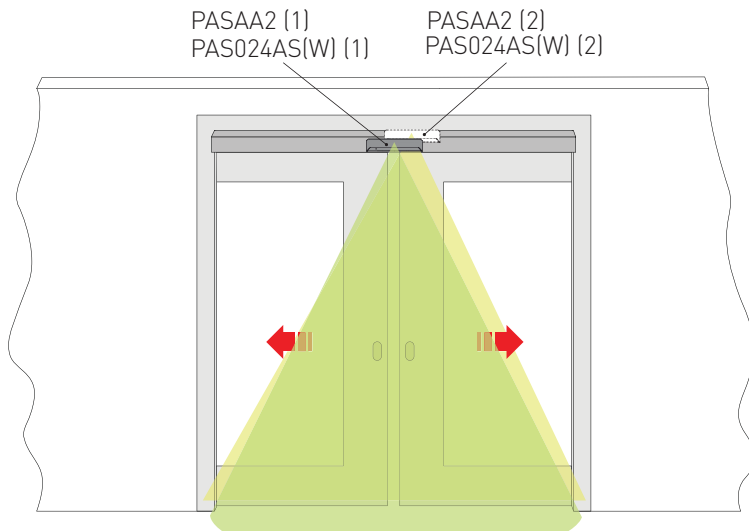

7.1 Nenhum sensor de segurança

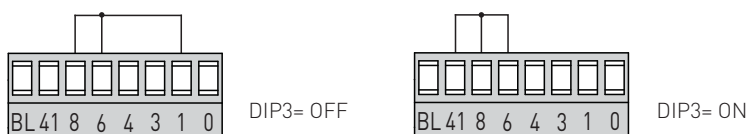

7.2 Sensores de abertura e segurança (1 e 2)

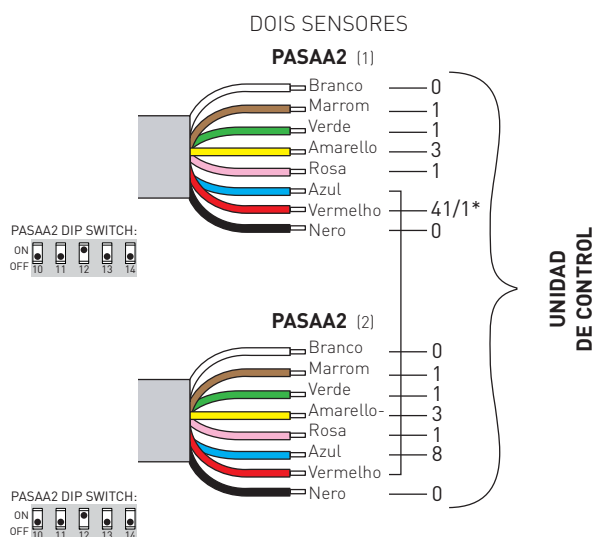
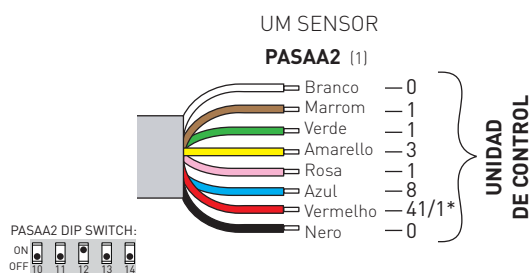

i * Conecte ao 41 se DIP3= ON; conectar em 1 se DIP3= OFF

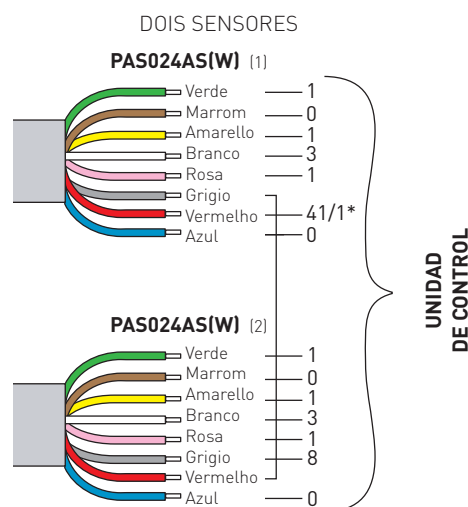
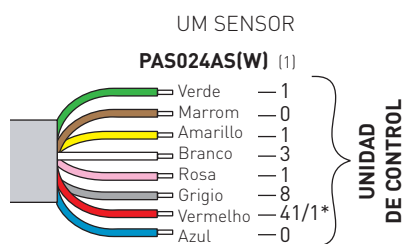

i * Conecte ao 41 se DIP3= ON; conectar em 1 se DIP3= OFF

8. ARRANQUE

- Ligue os acessórios;
- Ligue com ponte os contactos de segurança 1-8 e 1-6 (41-8 e 41-6 se DIP3= ON) no quadro elétrico se não utilizados;
- Ligue a alimentação de rede ao automatismo.
- Habilite a regulação dos trimmers/dip switches (consulte o parágrafo 5.3);
- Selecione os dip 1, 2, 3 e o trimmer VC conforme o funcionamento desejado (consulte o parágrafo 5.3);
- Selecione os dip "weight " 1, 2, 3 de acordo com o peso da portinhola se quiser utilizar o automatismo com desempenho LOW ENERGY (consulte o parágrafo 6).

ATENÇÃO: a cada ignição o quadro elétrico executa um RESET automático e o primeiro movimento de abertura ou fecho é executado com baixa velocidade e permite a aprendizagem automática das posições de batida (aquisição).

- Controle o correto funcionamento da porta com o sucessivo comando abre.
- Verifique o funcionamento dos acessórios ligados.
- Se o automatismo encontrar um obstáculo durante o curso de fecho, este obstáculo é detetado e a porta abre novamente. Se encontrar um obstáculo durante o curso de abertura, este obstáculo é detetado e a porta para seu movimento. Se o obstáculo for levantado por três vezes em seguida, é considerado como uma nova batida de paragem até quando não for removido.
- O automatismo é dotado da função Push&Go/Pull&Close. Empurrando a mão a porta, tanto ao abrir quanto ao fechar, a manobra motorizada é inicializada.



Se a automação não estiver ligada, é possível deslizar as portas manualmente, mas apenas movendo-as lentamente.

9. PLANO DE MANUTENÇÃO ORDINÁRIA

Realize as seguintes operações e verificações a cada 6 meses, em base à intensidade de utilização do automatismo.

Sem alimentação 230V~:

- Limpar as partes em movimento (as guias de deslizamento dos carrinhos).
- Controlar a tensão da correia.
- Limpar os sensores de abertura e fecho (se presentes).
- Controlar a estabilidade do automatismo e verificar o aperto de todos os parafusos.
- Verificar o correto alinhamento da portinhola e a posição das batidas.

Dar novamente alimentação 230V~:

- Controlar a estabilidade da porta e que o movimento esteja sendo regular e sem atritos.
- Controlar o correto funcionamento de todas as funções de comando.
- Controlar o correto funcionamento dos sensores de abertura e fecho (se presentes).
- Verificar se a instalação está em conformidade com as normas vigentes e os requisitos essenciais impostos pelas autoridades competentes.



NOTA: para as partes de reposição, fazer referência ao catálogo de peças de reposição.



Para a eventual reparação ou a substituição dos produtos deverão ser utilizadas exclusivamente peças de reposição originais. O instalador deve fornecer todas as informações relativas ao funcionamento automático, manual e de emergência do automatismo ou portão motorizado e entregar ao utilizador as instruções de uso. O instalador deve redigir o registo de manutenção, no qual deverá indicar todas as intervenções de manutenção de rotina e suplementar realizadas.



Entrematic Group AB
Lodjursgatan 10
SE-261 44, Landskrona
Sweden
www.entrematic.com